



215



ENGLISH

EFFER
RAISE THE VALUE



ICON 215

An excellent product along with extraordinary quality are not enough for us. We strive to increase your value because **we want you to realize your full potential and go beyond.** We share the same goals and the choice to aim for the top, and **we are committed to offering the best performance in every detail.**

Beautiful & Smart

ICON 215 also means **aesthetics and attention to detail**: this is reflected in its slender and sporty lines. Even the new housings in high-tech materials stand out with their sophisticated design that enhances the crane's look. Plus, ICON 215 has **exceptional technical features** and top reliability solutions.

Versatile & Compact

Thanks to the **external motor gear**, ICON 215 has very compact size allowing the operator to have a **higher payload on the truck**. Moreover, it is versatile and reliable to carry out different work in combination with different accessories (bucket, grab, brick grab etc.).

Light & Strong

ICON 215 is a light range crane, but it is not afraid of hard work. Thanks to its **high-strength steel structure**, ICON 215 guarantees very high operating performance.



Technical possibilities

Total control

On ICON 215 you can also manage **other electronic truck-related features** by remote control (e.g. switching on and switching off the engine). **PROGRESS 2.0** also allows you to integrate **other operating functions**: front stabilizers, truck-body sides, towing winch, grab, bucket, etc.



Lifting the maximum weight

Load capacity of ICON 215, calculated by Progress 2.0, is always maximized. In fact the extension of its stabilisers is **perfectly measured thanks to Encoder or magnetic sensors**.

Air geometries

PROGRESS 2.0 allows you to check and keep under control **the geometrical arrangement of the crane booms** both on the remote control display and the panel on ICON 215 base.



No oversight

PROGRESS 2.0 stores **the crane operating cycles** and faults detected, and **indicates scheduled maintenance operations**.

Working areas

PROGRESS 2.0 manages **4 different crane working areas**: front, back, left and right, providing maximum load capacity **according to the truck's stability scheme and the actual extension of its stabilizers**.

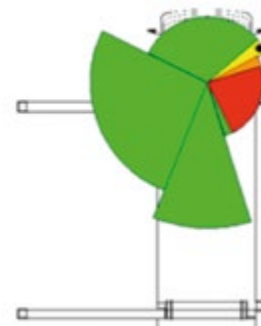

Remote help

When needed, **remote assistance** can be activated by the dealer or by **Effer headquarters**.



Technical possibilities

Smart Heat Exchanger

PROGRESS 2.0 system manages oil temperature. The heat exchanger is constantly working to **reduce energy consumption and oil overheating**, so extending life span of all components.



Max Speed Limitation (MSL)

Thanks to PROGRESS 2.0 system it is possible to manage crane hook speed, during simultaneous movements of the booms. In this way, **load swings are reduced** and shocks to the crane structure are avoided.



Assisted Winch Control

Recovery rope during boom section extension/retraction. With this feature, the winch rope moves along together with the extensions. The system **maintains a constant distance from the boom load**. In this way, the operator works faster and does not need to make correction manoeuvres. Load swing is drastically reduced allowing totally safe operating.

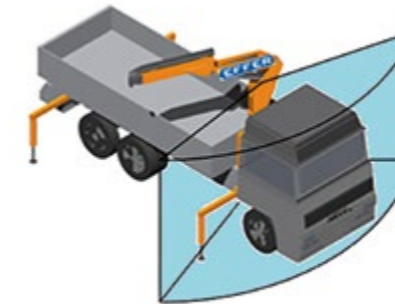

“Virtual shield” cabin-collision avoidance

PROGRESS 2.0 allows you to set a protected workspace around the cabin. In the proximity of this area, ICON 215 **movements are automatically stopped** to protect the cabin, thus eliminating the risk of accidental impact. You can also set a prohibited working area to **protect the manned workstation**.



Unload immediately without wasting time

It is possible to handle ICON 215 **without stabilizing it**, to quickly download from dumper.



Recovery System

In case of anomalies, PROGRESS 2.0 allows the operator to **park the crane in emergency mode**. This way you can quickly take the crane to the nearest Effer service point.

Stronger, further

Effer second boom and extensions

In the design stage of a truck-mounted crane, the crucial element in providing exceptional solutions is the **second boom and its junction with its relative extensions**.

Infact these components help to define crane performance in terms of boom length, working speed, lifting capacity and stress resistance.

Effer designers, thanks to their experience have come up with the following **exceptional production and technical solutions**:

- Boom section
- Lateral coupling
- Extension jacks: fastening by means of spring and advanced attachment
- Symmetrical lay-out of extension jacks
- Bronze side adjustment pads
- Large and multiple-folded hydraulic pipes
- High Speed System and Pro.Dec system
- Extensions come out in sequence starting from the strongest

New tubular guides system with inserts in graphite

Sliding pads and double guides (both on the upper and lower sides of tubulars) provide the following advantages:

- **A reduction** in mechanical backlash
- Extensions stay straight
- **Smooth extension and retraction** of the boom

SURGICAL PRECISION

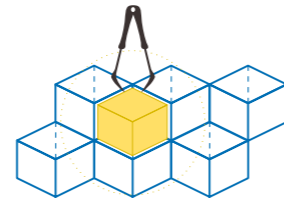

All in one piece

Boom and extensions are manufactured using a **single sheet of metal folded in various points** with **one internal and external robotic welding**.

Since the booms and extensions are made with a single welding the boom is made more resistant to strain over time.

The right capacity

Large pipe diameter reduces pressure and temperature of hydraulic fluid, so **avoiding power dissipation while working**. Plus, it guarantees a high working speed also under hard weather conditions, e.g. from the first manoeuvres in cold climates.

Unbeatable speed

Effer's experience has created **HSS – High Speed System**, included in all but some lighter models. The system, which uses a regeneration valve, makes the **extensions open more quickly** as it recovers the oil which would otherwise go into the tank.

The **High Speed System** allows you to save up to 50% of your time each time an extension is extended. The extensions coming out in sequence enable the crane weight to be reduced, and preserve **greater lifting power** and **greater loading capacity** for transport, so reducing working time.

LONG LASTING



TIME TO MONEY

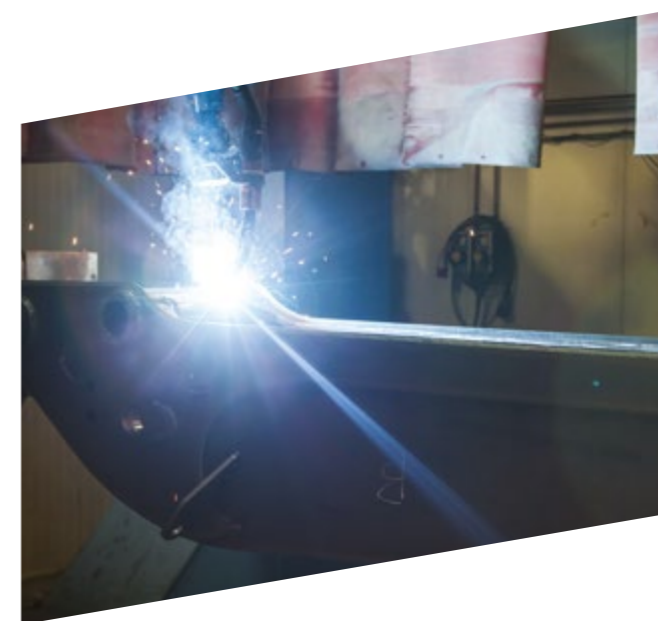

Light and powerful

The structure of Effer cranes

Effer cranes structure guarantees significant performance but at the same time you have a **very light crane** thanks to the design solutions engineered by Effer's R&D department. The light weight of Effer cranes allows for a greater residual load on the truck: **greater useful load = less time = higher profit.**

A step further

Effer uses high strength **Weldox** steel for crane structure. This choice **improves structure** resistance while maintaining the same plates thickness and allowing the most advanced construction solutions.

The right thickness where needed

Effer manufactures its cranes **optimising the thickness of sheets** at each point of the structure. This choice requires a great deal of effort be put in design and construction, but it enables **significant reduction in crane weight.**

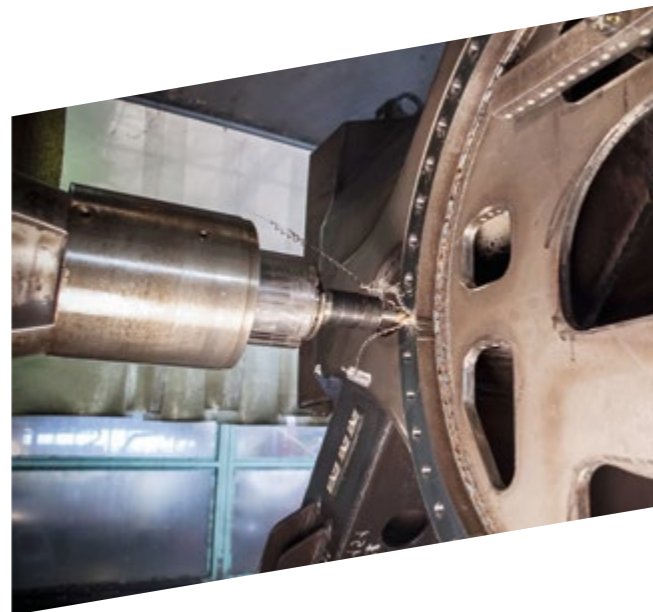

Wind&Drive system and Effer winch

A smart possibility for ICON

Today 70% of medium-large cranes are used with a winch. With Effer solution **Wind&Drive**, the winch cable pulleys are **integrated into the crane structure.** All operations needed to use the winch are thus eliminated: switching from "crane with hook" to "crane with winch" is **immediate, quicker and easier**, with better results in less time.

Total integration

The integration of the Wind & Drive and winch in the crane booms allows you to be **immediately operational without the need to mount components** at the beginning of the operating stages. It also allows you to **fold the crane quickly** at the end of the job.

Wind&Drive + PROGRESS 2.0

The Wind&Drive technology and PROGRESS 2.0 electronic control make **millimetric movements of the winch hook possible**, achieving maximum precision.

TIME TO MONEY



SURGICAL PRECISION

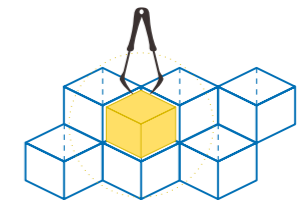

No mounting required

When working with the winch you can handle heavy loads using the fixed hook without needing to disassemble and re-assemble the components, thus **avoiding difficult operations.** Millimetric movements allow you to **place the load rapidly and extremely precisely.**

EASY WORK



Advantages

Maximum productivity on 360°

ICON 215 allows the operator to work at the best performances on 360° thanks to the **slewing ring** continuous rotation. ICON 215 is **the first crane in its category with this rotation system**: a feature that makes this machine really revolutionary for the market.

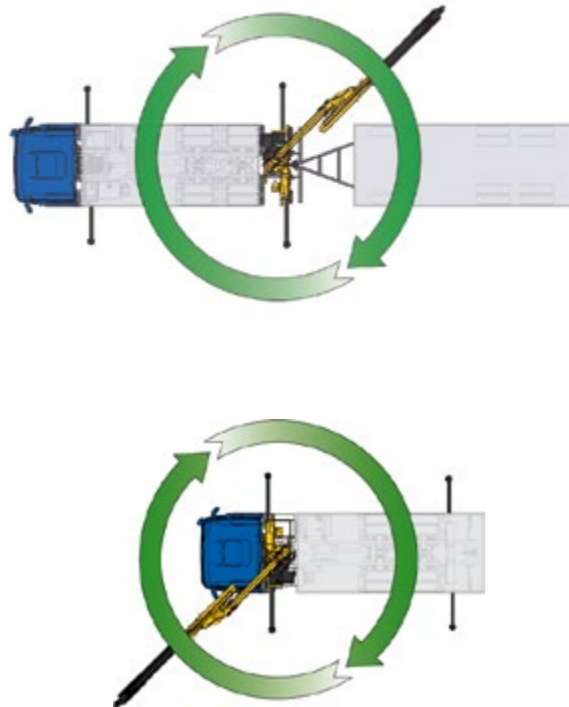

Protection and resistance

Plus, ICON 215 slewing ring is protected by a **carter in hi-tech material**, which is very resistant against shocks and dirt.



Compact size thanks to slewing ring with external motor gear

The truck body cut's thickness is very reduced: this allows you to mount a bigger chassis on the truck, thus gaining **more payload**.

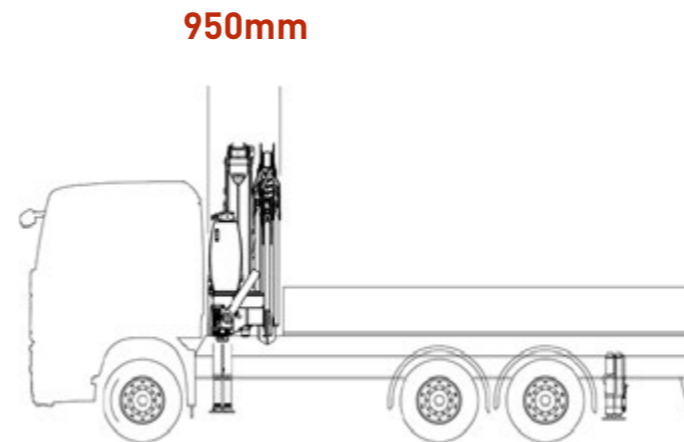

New system for hose support guide

It is very compact so it has a smaller size, and the structure is held up in 2 points: **this avoids vibrations** during operations.

SURGICAL PRECISION

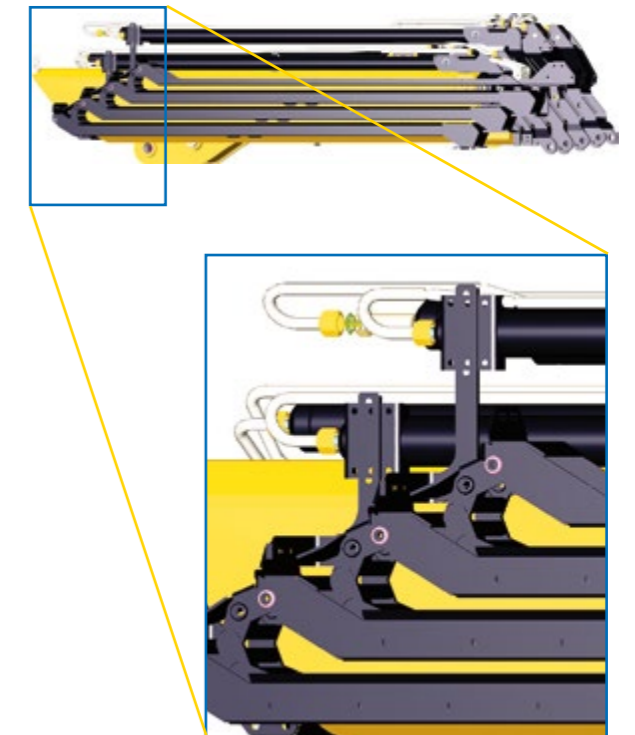
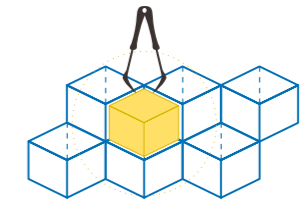

LONG LASTING



EASY WORK



Advantages

Advantages

Greater performance visibility

Information on performance is easy to consult thanks to the **new large-dimensioned stickers** put on the metal housing in a smart position for the operator. Greater visibility to work more safely.



Under a different light

The whole panel of the new electronic control system PROGRESS 2.0 is **always lit up for maximum visibility under all working conditions** (nocturnal work, low light) and for maximum ease of use. Moreover there is a new column for visual alerts.



Always balanced

Now **the spirit level is enlightened** with a LED visible also under bad weather conditions, and thanks to a play of mirrors it can be seen also frontally for maximum ease and rapidity during truck positioning.



Reliable support

On ICON cranes there is a **walk-on flooring** which is rigid and resistant, made in antislip aluminium plate, also protecting the elements below.



Facilitated access

The column side housing is very easy to open to **quickly access the distributor** without needing to demounting anything nor use tools. In case of need, the operator can directly access the heart of the crane, for example in case of emergency.



Metal housings

The housing, in metal, **covers the tank and protects connectors, pipes and components**. It's resistant, easy to clean and with minimalist, aesthetically pleasing design. This conception allows us to apply stickers on the housing with all information that the operator needs for an **intuitive consultation**. Also the oil cooler has a metal housing for maximum protection and durability over time.

Performance

C3S

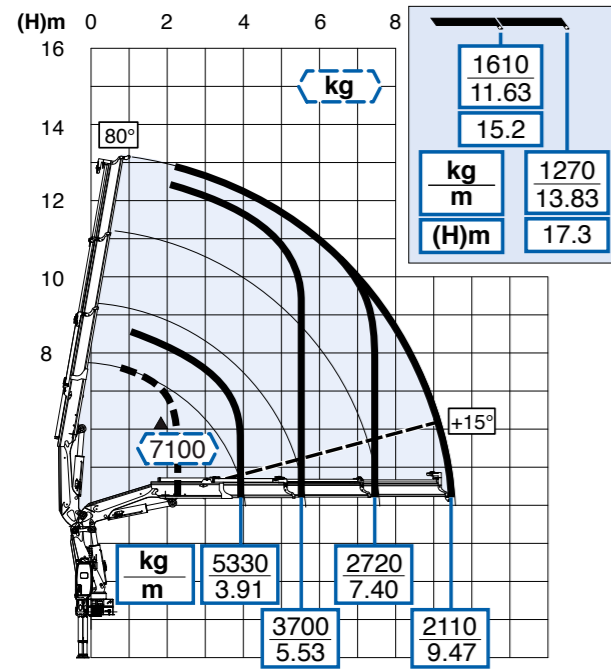

3S + JIB 3S

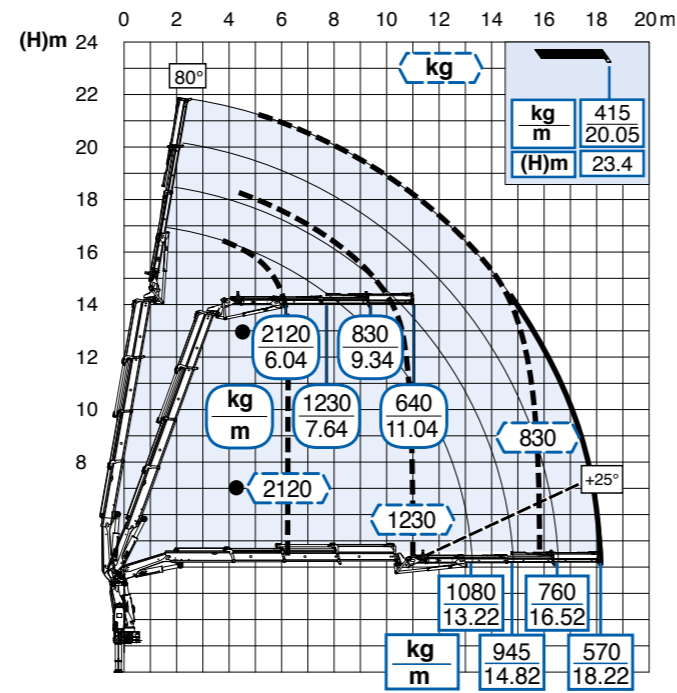

4S + JIB 4S

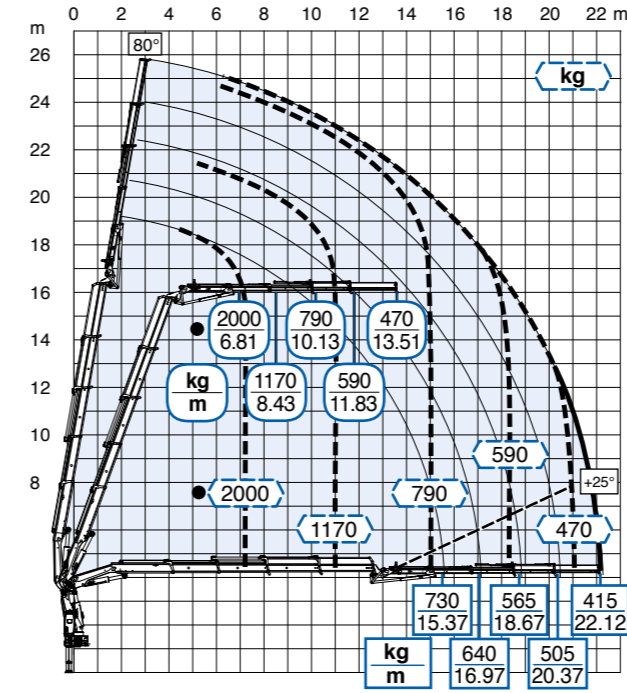

5S

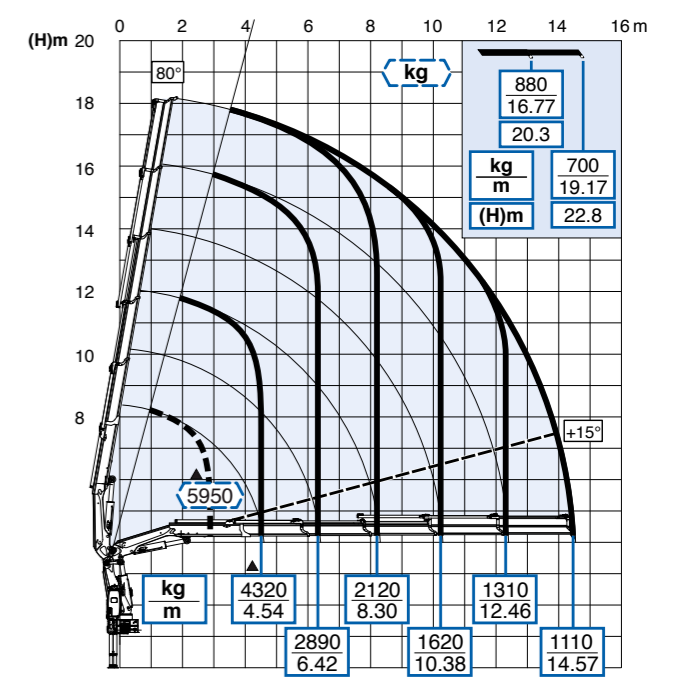

4S

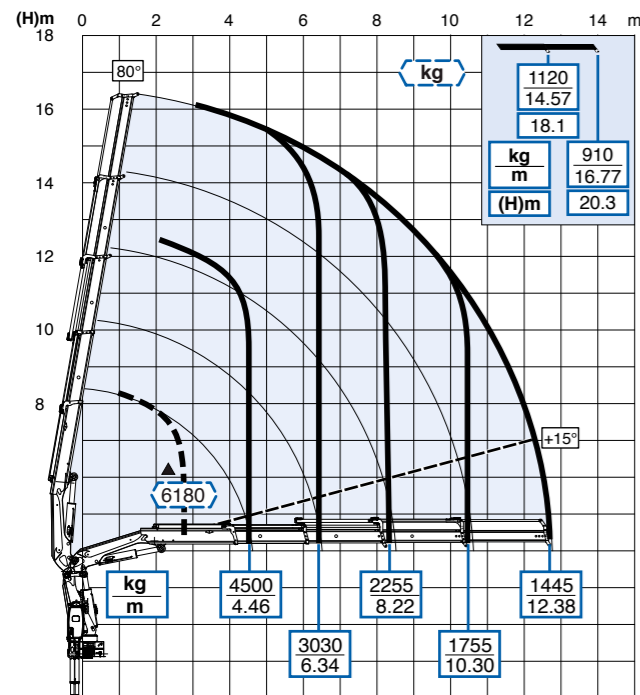

4S + JIB 3S

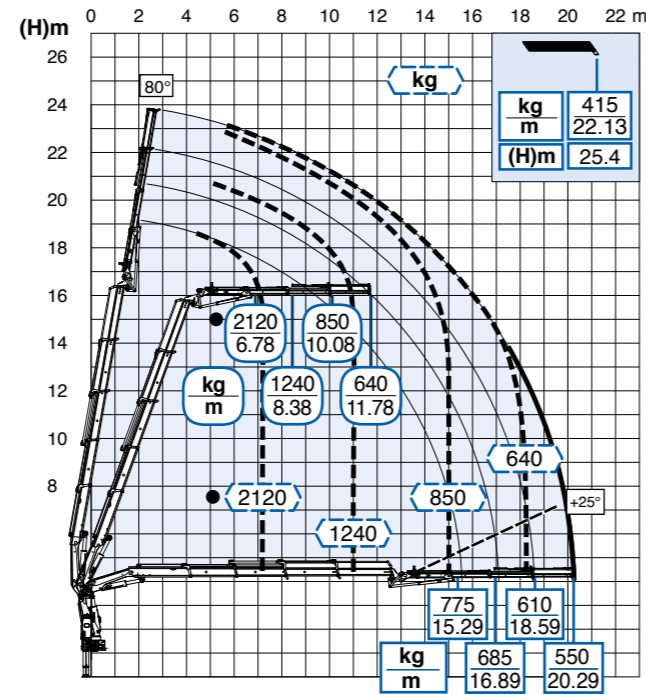

5S + JIB 2S

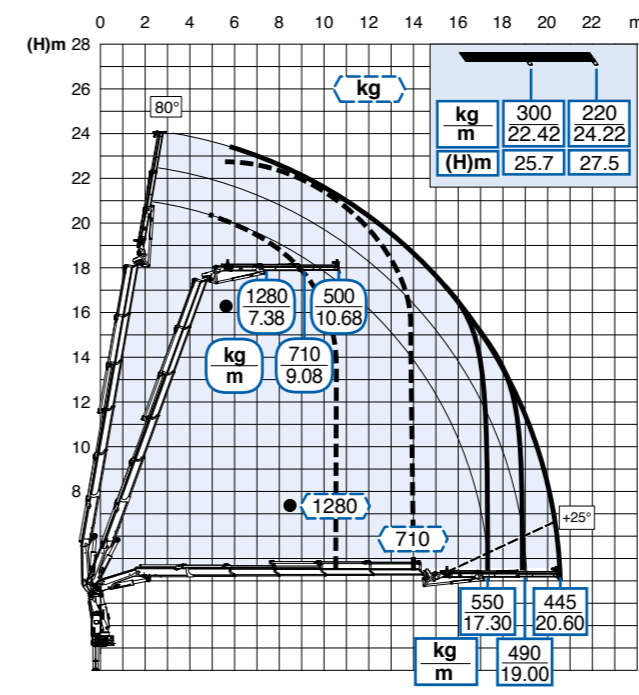

6S

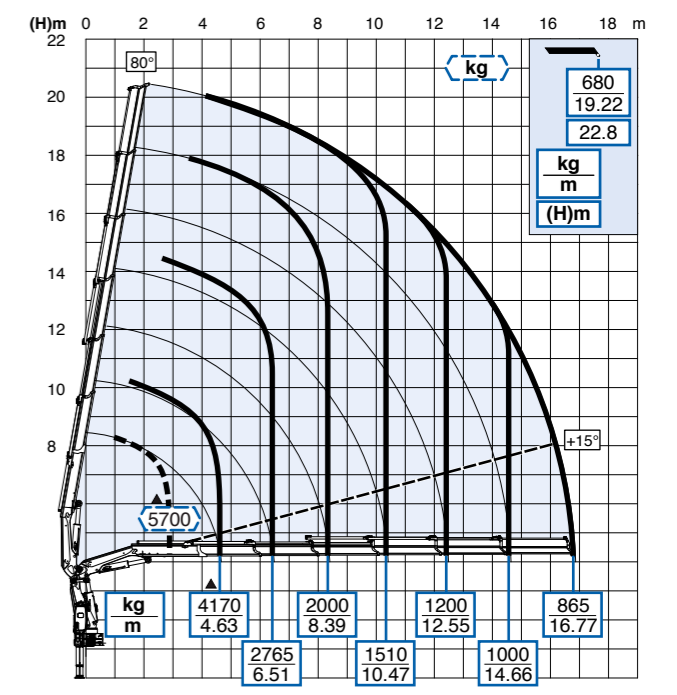



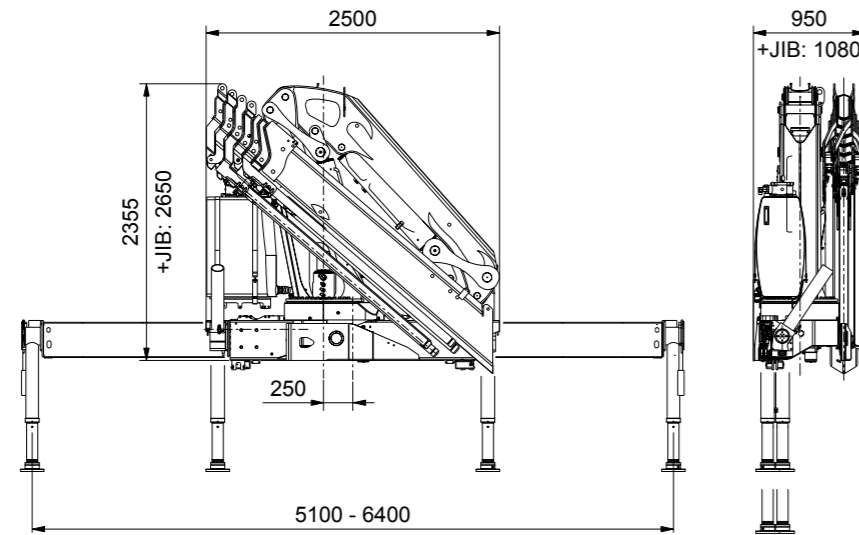









Technical data











DESCRIPTION	UNIT OF MEASURE	2S	3S	4S	5S	6S
Max. hydraulic outreach	m	8,16	10,35	12,52	14,71	16,91
Max. lifting moment (+20°)	kgm	20920	20455	20050	19610	19310
	kNm	205	201	197	192	189
Slewing arc	(°)	endless				
Slewing Capacity - Max slope	%	8,7				
Working pressure	bar	360				
Recommended oil delivery	l/min	100				
Oil tank capacity	l	140				
Weight of the standard crane (± 2%)	kg	2500	2645	2785	2915	3030

Standards

-  Hexagonal profile booms
-  Rotation with slewing ring and gear motor
-  ETL (Effer Twin Links)
-  Sequence valve
-  Jib articulation system above 180°
-  Heat exchanger
-  Remote control with display
-  Stabilizers with hydraulic outlet
-  "High Speed System" increased speed of extensions cylinders
-  "Pro.Dec. System" cylinders with progressive stop at end of stroke
-  Jib articulation system above 180°
-  PROGRESS 2.0
-  Remote control for stabilisers

Optionals

-  "Wind & Drive" Crane foldable with fly-jib without dismounting winch components
-  Swing-up stabilizers, manually activated
-  Swing-up stabilizers, hydraulically activated
-  Winch
-  H Version, basic version for Countries outside the EU, ask Effer sales department for technical details
-  Crane adjustment and joint for PLE
-  Remote control with joystick
-  Load reading on the remote control display
-  Version C
-  DLC Dynamic Load Chart: Load diagram visualization on radiocontrol display
-  Sense: Crane advanced stability system
-  RACE: Remote Assistance Control Effer

CRANE DESIGNED ACCORDING TO STANDARDS UNI EN 12999 HC1 S1 HD5

The configurations and figures contained in the brochure are illustrative. For information on the complete offer and for more technical details, ask your Effer dealer or consult the website www.effer.com. The above data are subject to change. Lifting capacity is based on the maximum lifting power of the crane. The stability of the truck may require a reduction of lifting capacity.

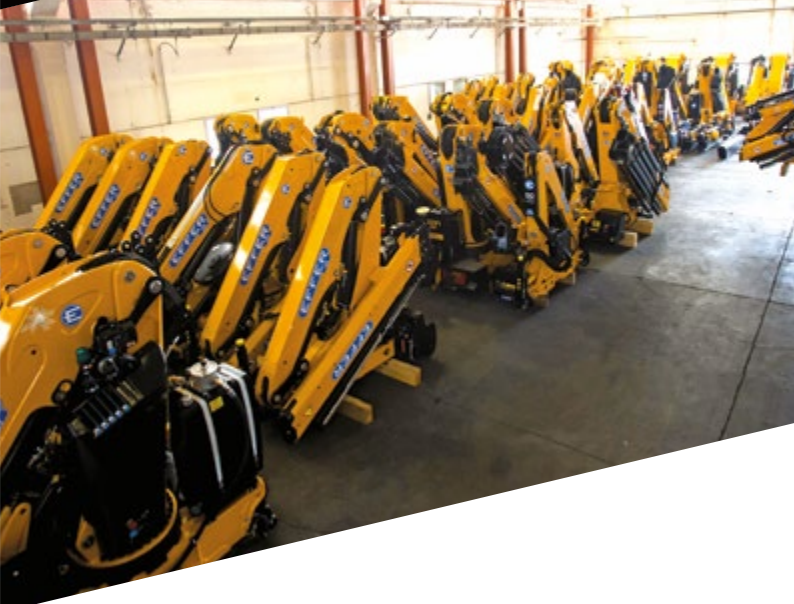

EFFER S.p.A.

Via IV Novembre, 12 | 40061 Minerbio (BO) – Italy
Tel. +39 051 4181211 | Fax. +39 051 4181491
S.P. 40 ex Vicinale Accetta Grande | 74010 Statte (TA) – Italy
Tel +39 099 4700191 | Fax +39 09 9 4700189
contact@effer.com

www.effer.com | www.effermarine.com

Effer is part of Hiab

