

25/30/33L-9A

LPG Counterbalance Trucks

MOVING YOU FURTHER

HYUNDAI HEAVY INDUSTRIES



■ Photo may include optional equipment

 **HYUNDAI**

Your satisfaction is **our priority!**

Hyundai introduces a new line of 9-series LPG forklift trucks. The newly designed 4 wheel counterbalance trucks provide every operator comfortable driving, increased productivity and easy maintenance.



New LPG forklift with proven quality and advanced technology

- Maximum performance
- Spacious operator's cab
- Switch type parking brake
- 5.6 inch LCD color monitor
- Truck inclination warning system
- OPSS System for safe operation
- Easy serviceability
- Max speed limit function
- HAC (Hillstart-Assistance Control)
- Password starting system
- Load weight indicator
- Auto fork leveling system (Optional)



■ Photo may include optional equipment

High Efficiency & Optimal Performance

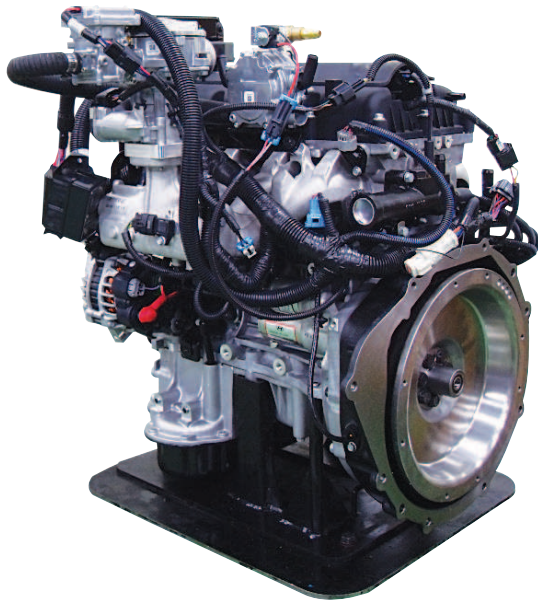

HMC L4KB(2.4L) Engine 60PS / 2,300 rpm

Powerful Engine - HMC L4KB(2.4L)

Market approved quality of HMC L4KB engine ensures incomparable performance, durability and additional value to the machine. Powerful and efficient engine provides excellent fuel consumption and excellent torque. (EPA/CARB Tier-IV Certified)

Highly durable drive axle

The strengthened drive axle separable from transmission ensures low vibration and easy maintenance. The wet disc type brake is applied for easy operation, smooth response and maintenance free.

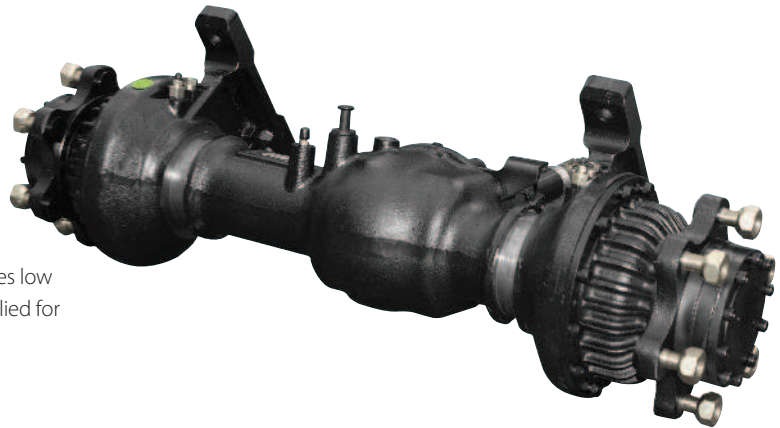

Fully Hydrostatic Power Steering

The hydraulic steering system always guarantees smooth and flexible steering, preventing over-run and kick-back.

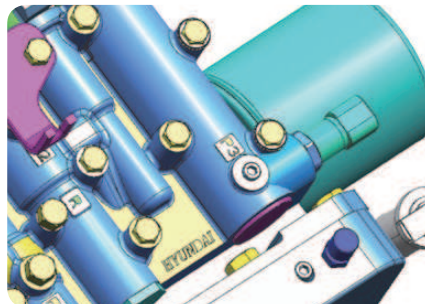

Clutch Protection System

The clutch protection system prevents excessive use of inching and minimizes change-impact.



Boosting Type Brake System (Optional)

The boosting type brake valve is applied for strong braking performance.

Powerful engine and high technology systems provide you with enhanced performance and highest productivity.

25/30/33L-9A

**7.5%
Faster Speed**

**7.0%
Greater Power**

(Compared to 7A Series)



■ Photo may include optional equipment

Faster Travel Speed & Gradeability

The powerful high-output engine provides greater acceleration, better gradeability and faster travel speed on any tough terrain or slope.

Max. Travel Speed

Model	Km / h
25L-9A	18.0
30L-9A	18.9
33L-9A	18.9

Max. Gradeability

Model	%
25L-9A	35.2
30L-9A	28.3
33L-9A	26.0

Best Convenience & Optimized Ergonomics



Spacious Operator Cabin

The newly designed cabin provides wide visibility and spacious environment, ensuring all day comfort for the operator.

Comfortable Grammer Seat

Easily adjustable suspension seat, based on a human engineering design, reduces operator fatigue and provides greater comfort.

* ELR (Energy Locking Retractor) Type Seat Belt

* Heating and Head-rest (OPT)



Adjustable Steering Wheel

To achieve a comfortable drive position, the angle of the steering column can easily be adjusted by a lever on the right-hand side of the steering column.



Fingertip (Optional)

Ergonomically designed fingertip control levers reduces operator's fatigue by eliminating the arm and shoulder movement reaches and awkward shoulder. It gives operators comfortability and efficiency.



Levers

Newly designed manual levers enable precise and sensitive control of all functions with an ergonomic gripping.

The ergonomically designed cabin and the new style LCD color monitor provides full support and comfort to the operator.

25/30/33L-9A

Advanced LCD Monitor

The 5.6 inch wide screen LCD color monitor allows the operator to control the machine with ease. The monitor features speed, travel direction, battery discharge indicator and hour meter.

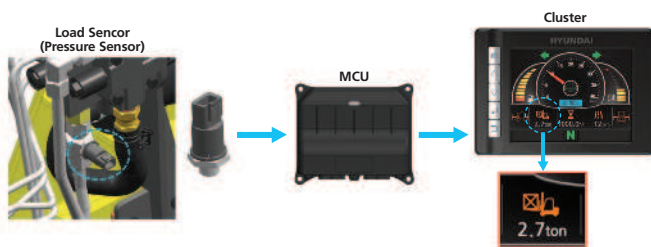

Load Indicator

The optional load indicator displays the load weight on the monitor. The load sensor reduces the time to check loaded weight and the alarm alerts the driver when overloaded.



Auto Fork Leveling System (Optional)

To improve the productivity, the auto fork leveling system will automatically stop the tilt movement when the mast is in a straight position.

Advanced **Safety**



Excellent Visibility for Safe Operation

■ Photo may include optional equipment

Optimized lift cylinder arrangement provides operator with wider visibility. The panoramic mirror expands the driver's view when backing up.



Strong Overhead Guard

Exceeding ISO6055 and ANSI regulations, the overhead guard offers optimal protection combined with excellent all round visibility.



Low Entrance Height

The low entrance height ensures easy and safe access for the operator.



Rear Horn (Optional)

Allowing operators hand to remain within forklift at all times for safety. An integral horn switch can prevent any hazardous situation at reverse mode.

The safely designed driver's space makes your operating more comfortable.

25/30/33L-9A



HAC (Hill Start Assist Control System)

Anti-roll back the truck when the truck restart in the slope way.

Travel Speed Control System (Optional)



In-Door : Adjustable Max. Travel Speed (5 ~ 16 km/h)

Out-Door : Max Travel Speed (18.9 km/h for 30L-9A)

Fork Safety Features

When the forks are being lowered, a down-control valve maintains the controlled speed. The down-safety valve prevents forks from dropping down in case of sudden damage of hydraulic line.



■ Photo may include optional equipment



Safety Lamps & Rear Reflectors

Halogen headlights and rear LED combination lights offer the driver visibility in all circumstances. Rear reflectors mounted on the counterweight enhance safety for the driver and the application. *Full LED lamp are available.

Fast and Easy Maintenance

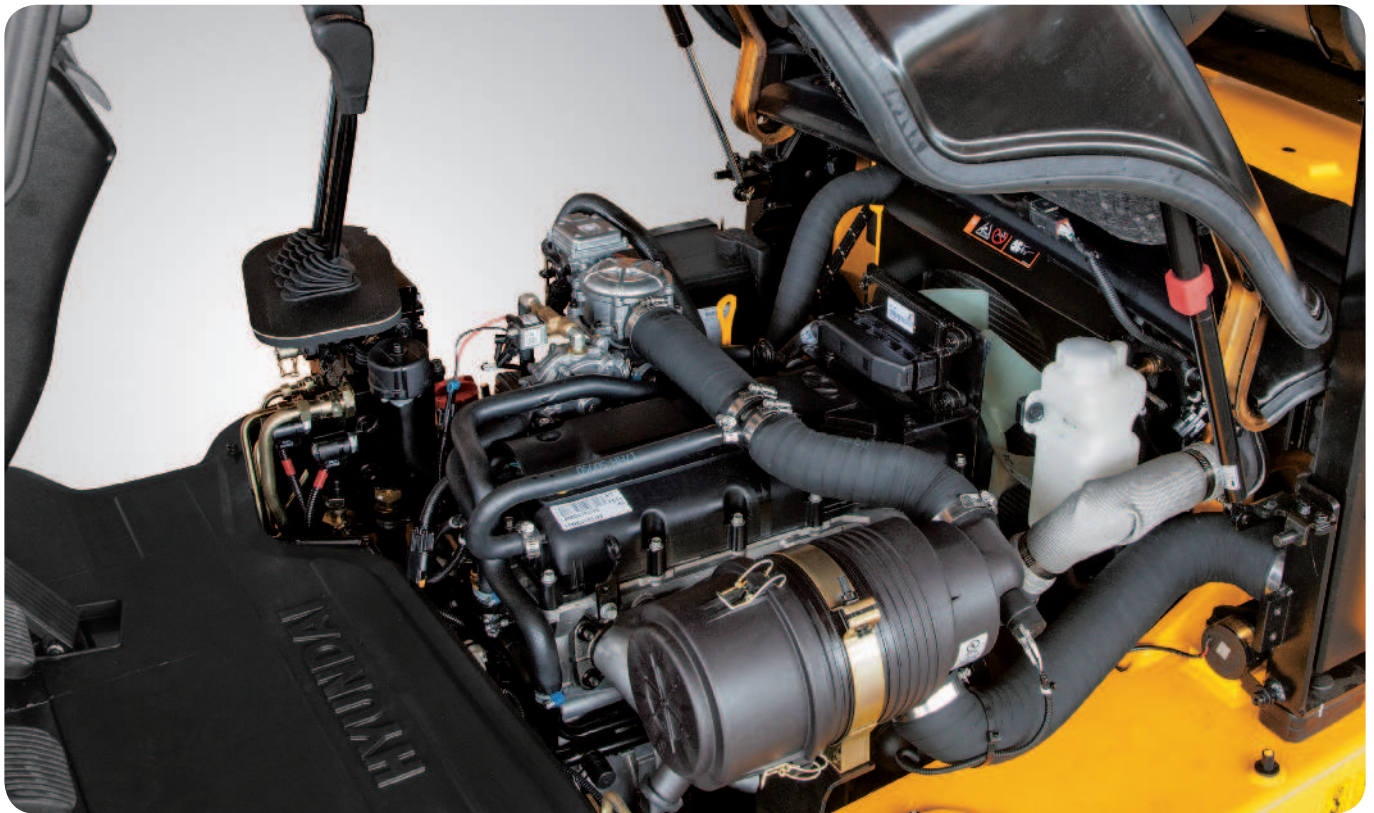

Large Engine Hood

Highly accessible engine compartment assures fast and efficient maintenance.
The enlarged air cleaner(7") has extended service time of engine.

■ Photo may include optional equipment

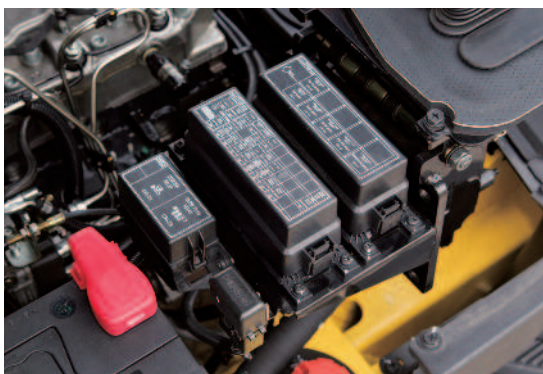

Waterproof & Dustproof Cover

Newly developed Waterproof and Dustproof fuse box and relay box for ease of maintenance.

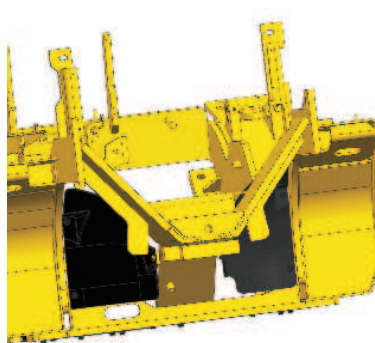

Rear Tire Cover (Optional)

The rear tire cover with PE material is well-suited to prevent clogging of the radiator from foreign substances.

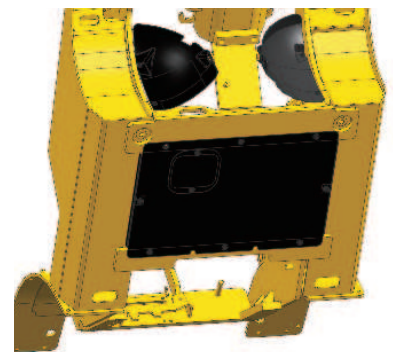

Under Cover (Optional)

The Under cover protect the engine and components from dusts caused by ground. It helps to lengthen components life.

An ideal arrangement of components ensures easy access and convenience for maintenance.

25/30/33L-9A



Rear View Camera
(Optional)



Parking Brake Switch

With auto parking function when the operator is not in the seat



Emergency switch
(option)

■ Photo may include optional equipment



Maintenance Management display

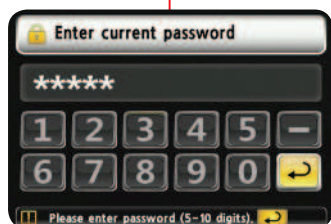

Password Starting System
(Anti-theft system)

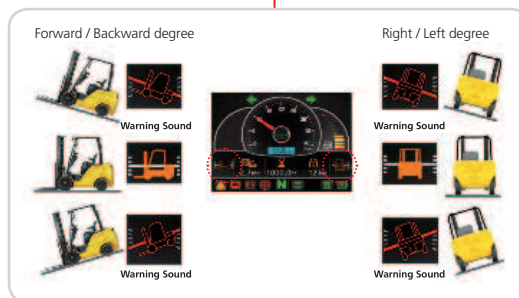

Truck Inclination Warning System

Mast Specification (33L-9A)

Mast Type	Maximum Fork Height		Overall Height (Lowered)		Free Lift Height				Tilt Angle	Load Capacity without side shift				Load Capacity with side shift				Truck Weight (Unloaded)				
					With Load Backrest		Without Load Backrest			Single Tire		Double Tire		Single Tire		Double Tire		Single Tire		Double Tire		
	inch	mm	inch	mm	inch	mm	inch	mm	(deg)	24 in LC	500 mm LC	24 in LC	500 mm LC	24 in LC	500 mm LC	24 in LC	500 mm LC	lb	kg	lb	kg	
										lb	kg	lb	kg	lb	kg	lb	kg	lb	kg	lb	kg	
2-Stage Limited free lift	V300	118.3	3005	83.1	2110	4.5	155	4.5	155	6 / 10	6500	3300	6500	3300	6500	3300	6500	3300	9636	4371	9923	4501
	*V330	130.1	3305	89.0	2260	4.5	155	4.5	155	6 / 10	6500	3300	6500	3300	6500	3300	6500	3300	9689	4395	9976	4525
	V350	138.0	3505	92.9	2360	4.5	155	4.5	155	6 / 10	6500	3300	6500	3300	6500	3300	6500	3300	9722	4410	10011	4541
	V370	145.9	3705	98.8	2510	4.5	155	4.5	155	6 / 10	6500	3300	6500	3300	6500	3210	6500	3300	9755	4425	10040	4554
	V400	157.7	4005	104.7	2660	4.5	155	4.5	155	6 / 10	6500	3300	6500	3300	6500	3120	6500	3300	9846	4466	10132	4596
	V430	169.5	4305	110.6	2810	4.5	155	4.5	155	6 / 6	6500	3250	6500	3300	6500	3070	6500	3250	9965	4520	10251	4650
	V450	177.4	4505	116.5	2960	4.5	155	4.5	155	6 / 6	6500	3190	6500	3300	6500	3010	6500	3125	10015	4543	10304	4674
	V470	185.2	4705	120.5	3060	4.5	155	4.5	155	6 / 6	6500	3140	6500	3240	6300	2960	6500	3065	10051	4559	10337	4689
V500	197.0	5005	126.4	3210	4.5	155	4.5	155	6 / 6	6420	3100	6500	3170	6120	2920	6500	2995	10104	4583	10390	4713	
2-Stage full free lift	VF295 / VS295	117.2	2976	83.1	2110	36.6	930	54.5	1384	6 / 6	6500	3300	6500	3300	6500	3300	6500	3300	9819	4454	10099	4581
	VF325 / VS325	129.0	3276	88.3	2260	41.9	1080	60.1	1534	6 / 6	6500	3300	6500	3300	6500	3210	6500	3300	9899	4490	10179	4617
	VF345 / VS345	136.9	3476	89.0	2260	46.5	1180	64.3	1634	6 / 6	6500	3300	6500	3300	6500	3120	6500	3250	9976	4525	10254	4651
3-Stage full free lift	TF370/TS370	145.9	3705	75.2	1910	28.7	730	43.9	1114	6 / 6	6500	3300	6500	3300	6500	3120	6500	3250	10135	4597	10414	4724
	TF400/TS400	157.7	4005	79.1	2010	32.7	830	47.8	1214	6 / 6	6500	3250	6500	3300	6500	3070	6500	3125	10183	4619	10463	4746
	TF430/TS430	169.5	4305	83.1	2110	36.6	930	51.7	1314	6 / 6	6500	3180	6500	3280	6500	3000	6500	3105	10229	4640	10509	4767
	TF450/TS450	177.4	4505	87.0	2210	40.6	1030	55.7	1414	6 / 6	6500	3120	6500	3220	6270	2940	6500	3045	10276	4661	10558	4789
	TF470/TS470	185.2	4705	89.0	2260	42.5	1080	57.6	1464	6 / 6	6350	3080	6500	3170	6050	2900	6290	2995	10306	4675	10586	4802
	TF500/TS500	197.0	5005	92.9	2360	46.5	1180	61.6	1564	6 / 6	6260	3030	6390	3110	5960	2850	6090	2935	10355	4697	10635	4824
	TF550/TS550	216.7	5505	100.8	2560	54.3	1380	69.4	1764	6 / 6	4560	2200	6170	2990	4260	2020	5870	2815	10452	4741	10732	4868
	TF600/TS600	236.4	6005	108.7	2760	62.2	1580	77.3	1964	6 / 6	3130	1500	5950	2870	2830	1320	5650	2695	10613	4814	10893	4941
TF650/TS650	256.1	6505	116.5	2960	70.1	1780	85.2	2164	3 / 3	3060	1450	5910	2830	2760	1280	5610	2655	10719	4862	10999	4989	
TF700/TS700	275.8	7005	124.4	3160	78.0	1980	93.1	2364	3 / 3	2650	1250	5710	2730	2350	1080	5410	2555	10809	4903	11089	5030	
4-Stage full free lift	QF610	240.7	6115	87.6	2225	41.1	1045	57.0	1449	3 / 3	3750	1800	5930	2870	3450	1620	5630	2695	10891	4940	11182	5072
	QF660	260.4	6615	95.5	2425	49.0	1245	64.9	1649	3 / 3	3330	1600	5730	2770	3030	1420	5430	2595	11023	5000	11314	5132
	QF700	276.2	7015	99.4	2525	53.0	1345	68.9	1749	3 / 3	2710	1300	5600	2700	2410	1120	5300	2525	11089	5030	11380	5162
	QF745	293.9	7465	105.3	2675	58.9	1495	74.8	1899	3 / 3	2090	1000	5420	2620	1790	820	5210	2445	11184	5073	11475	5205
	QF790	311.6	7915	111.2	2825	64.8	1645	80.7	2049	3 / 3	1680	800	5250	2530	1380	620	4950	2355	11411	5176	11704	5309

Optional Items

• Fork (mm)

25L-9A : 900; 1000; 1050 (STD); 1200; 1350; 1500; 1650; 1800; 2100
 30/33L-9A : 900; 1050 (STD); 1150; 1200; 1650; 1800; 1970; 2120; 2300; 2400

• Overshoe (mm)

25L-9A : 1300; 1500; 1700; 1800
 30/33L-9A : 1300; 1500; 1700; 1800

• Integral Sideshift; Fork Positioner; Sideshift;

Integral Fork Positioner with Sideshift

• Tire : Solid (superelastic) / Non-marking / Front double tire

• M.C.V : 4-Spool

• Seat : Armrest; Heat; Backrest Ext; Buckle SW

• Auto Fork Leveling System

• Rear View Camera

• Load Indicator

• Hydraulic Pump Temperature / Pressure Indication

• Battery Disconnect Switch (Master Switch)

• Beacon Lamp (LED) (Amber; Red; Blue)

• Rear work Lamp (LED)

• F-N-R & Horn Knob switch (Manual Lever)

• Rear Horn with Handle

• Finger Tip Control Lever (4-spool) (with F-N-R & Horn switch)

• Hydro Accumulator

• Blue Spot (Rear)

• Travel Speed Control System

• Side & Panoramic Mirror

- Side Mirror (RH/LH)

- Panoramic Mirror

- Side (LH) & Panoramic Mirror

- Side (LH/RH) & Panoramic Mirror

■ The Specifications in this brochure are subject to change for option.

■ The options in this brochure are subject to change to improve the performance of the forklift.

New 9 Series

Dimensions

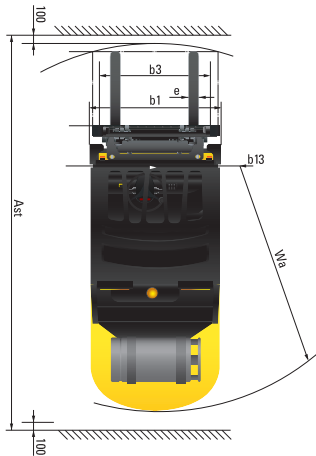
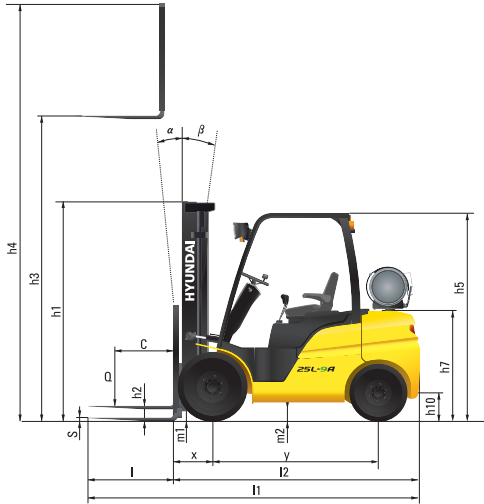

- The Specifications in this brochure are subject to change for option.
- The options in this brochure are subject to change to improve the performance of the forklift.

Specifications

General Information

1.1	Manufacturer	Hyundai	Hyundai	Hyundai
1.2	Model Manufacturer's Designation	25L-9A	30L-9A	33L-9A
1.3	Drive: electric (battery or mains), diesel, petrol, fuel gas, manual	LPG	LPG	LPG
1.4	Type of operation: hand, pedestrian, standing, seated, order-picker	seated	seated	seated
1.5	Load capacity / rated load	kg (lb) 2500 (5000)	3000 (6000)	3300 (6500)
1.6	Load center distance	c mm (in) 500 (24)	500 (24)	500 (24)
1.8	Load distance, center of drive axle to fork	x mm (in) 468 (18.4)	468 (18.4)	468 (18.4)
1.9	Wheelbase	y mm (in) 1650 (64.9)	1700 (66.9)	1700 (66.9)

Weights

2.1	Service weight	kg (lb) 3721 (8203)	4116 (9074)	4395 (9689)
2.2	Axle loading, loaded front / rear	kg (lb) 5491 (12106) / 731 (1612)	6298 (13885) / 818 (1803)	6727 (14831) / 968 (2134)
2.3	Axle loading, unloaded front / rear	kg (lb) 1524 (3360) / 2197 (4844)	1590 (3505) / 2526 (5569)	1548 (3413) / 2847 (6277)

Wheels, Chassis

3.1	Tires: solid rubber (V), superelastic (SE), pneumatic (P), polyurethane (PE)	P	P	P
3.2	Tires size, front	7.00-12,14PR	28x9-15,14PR	28x9-15,14PR
3.3	Tires size, rear	6.50-10,14PR	6.50-10,14PR	6.50-10,14PR
3.5	Number of wheels front / rear (x=driven wheels)	2x/2	2x/2	2x/2
3.6	Tires width, front	mm (in) 999 (39.3)	1005 (39.5)	1005 (39.5)
3.7	Tires width, rear	mm (in) 980 (38.5)	980 (38.5)	980 (38.5)

Basic Dimensions

4.1	Mast / fork carriage tilt forward / backward (a / b)	degrees	6/10	6/10	6/10
4.2	Lowered mast height	h1 mm (in)	2175 (85.6)	2190 (86.2)	2260 (88.9)
4.3	Free lift	h2 mm (in)	155 (6.1)	155 (6.1)	155 (6.1)
4.4	Lift height	h3 mm (in)	3305 (130.1)	3305 (130.1)	3305 (130.1)
4.5	Extended mast height	h4 mm (in)	4485 (176.5)	4485 (176.5)	4485 (176.5)
4.7	Overhead guard height [cabin]	h5 mm (in)	2160 (85.0) [2170 (85.4)]	2180 (85.8) [2190 (86.2)]	2180 (85.8) [2190 (86.2)]
4.8	Seat height / standing height rel. to SIP	h7 mm (in)	1187 (46.7)	1212 (47.7)	1212 (47.7)
4.12	Coupling height	h10 mm (in)	295 (11.6)	320 (12.5)	320 (12.5)
4.19	Overall length	l1 mm (in)	3657 (143.9)	3726 (146.6)	3782 (148.8)
4.20	Length to face of forks	l2 mm (in)	2607 (102.6)	2676 (105.3)	2732 (107.5)
4.21	Overall width	b1 mm (in)	1200 (47.2)	1228 (48.3)	1228 (48.3)
4.22	Fork dimensions (hook type)	s x e x l mm (in)	45 x 100 x 1050 (1.8 x 3.9 x 41.3)	45 x 122 x 1050 (1.8 x 4.8 x 41.3)	45 x 122 x 1050 (1.8 x 4.8 x 41.3)
4.23	Fork carriage ISO 2328, class / type A, B		2A	3A	3A
4.24	Fork-carriage width	b3 mm (in)	1102 (43.3)	1102 (43.3)	1102 (43.3)
4.31	Ground clearance, loaded, under mast	m1 mm (in)	130 (5.1)	145 (5.7)	145 (5.7)
4.32	Ground clearance, centre of wheelbase	m2 mm (in)	157 (6.1)	181 (7.1)	171 (6.7)
4.33	Aisle width for pallets 1,000 x 1,200 crossways (L x W)	Ast mm (in)	4010 (157.8)	4081 (160.6)	4131 (162.6)
4.34	Aisle width for pallets 800 x 1,200 lengthways (W x L)	Ast mm (in)	4210 (165.7)	4281 (168.5)	4331 (170.5)
4.35	Turning radius	Wa mm (in)	2342 (92.2)	2413 (94.9)	2463 (96.9)
4.36	Smallest pivot point distance	b13 mm (in)	714 (28.1)	731 (28.7)	731 (28.7)

Performance Data

5.1	Travel speed, unloaded	km / h (mph)	18.0 (11.2)	18.9 (12.4)	18.9 (12.4)
5.2	Lift speed, loaded / unloaded	mm / s (ft / min)	580 (114) / 590 (116)	570 (112) / 590 (116)	460 (90.6) / 480 (94.5)
5.3	Lowering speed, loaded/unloaded	mm / s (ft / min)	500 (98.4) / 450 (88.6)	500 (98.4) / 450 (88.6)	500 (98.4) / 450 (88.6)
5.6	Drawbar pull, loaded	N (lb)	22653 (5093)	21212 (4769)	21231 (4773)
5.8	Max. Gradient performance, loaded	%	35.2	28.3	26
5.9	Acceleration time, loaded / unloaded (10m)	sec	-	-	-
5.10	Service brake		Hydraulic	Hydraulic	Hydraulic

Engine

7.1	Engine manufacturer / type	HMC / L4KB	HMC / L4KB	HMC / L4KB
7.2	Engine power acc. to ISO 1585	PS / rpm	60 / 2300	60 / 2300
7.3	Maximum Torque	kgf·m (lbf·ft) / rpm	19 (137.4) / 1800	19 (137.4) / 1800
7.4	No. of cylinder / cubic capacity	EA / cc	4 / 2359	4 / 2359

Other Details

8.1	Type of drive control	Power Shift	Power Shift	Power Shift
8.2	Operating pressure, system / attach	bar (psi)	216 / 162 (3133 / 2350)	216 / 162 (3133 / 2350)
8.3	Oil volume for attachments (hydraulic)	lpm (GPM-US)	30 (60 Max.) (8 (16 Max.))	30 (60 Max.) (8 (16 Max.))
8.4	Sound pressure level (at driver's ear according to DIN 12053)	dB(A)	80	80
8.5	Trailer coupling, type DIN		PIN	PIN

New 9 Series

Load Capacity

25L-9A

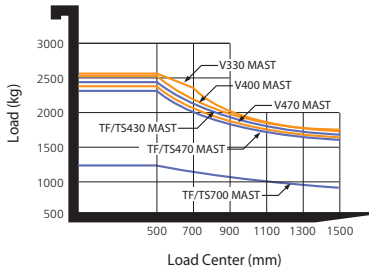

30L-9A

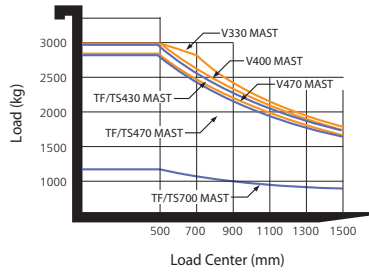

33L-9A

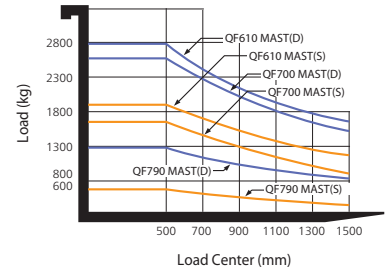
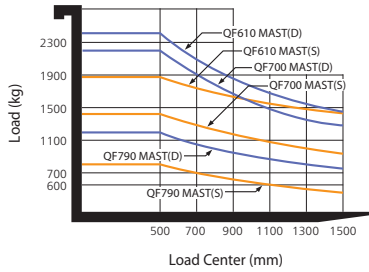
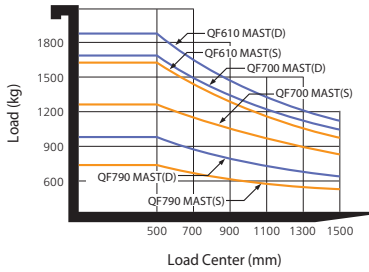
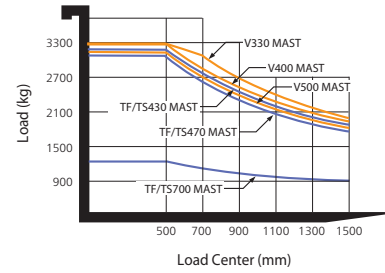

Various Attachments

Side Shift

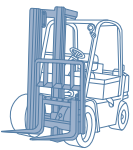

Hinged Fork

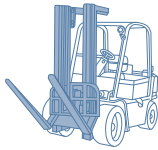

Hinged Bucket

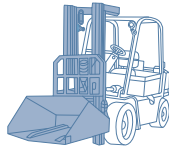

Rotating Fork

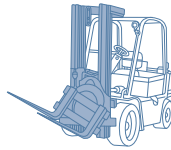

Push Pull

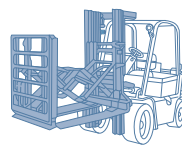

Rotating Roll Clamp

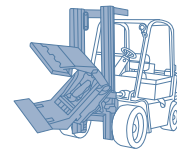

Load Stabilizer

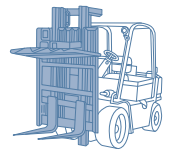

Carton Clamp

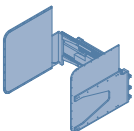

Pallet Invert

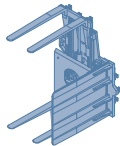

Drum Clamp

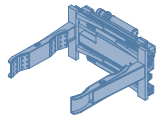

Bale Clamp

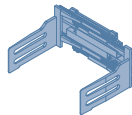

Load Extender

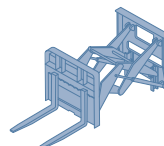

Fork Positioner

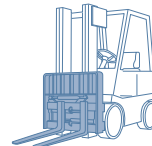

- * Standard and optional equipment may vary per country. Contact your Hyundai dealer for more information.
- * The photos may include attachments and optional equipment that are not available in your area.
- * Materials and specifications are subject to change without advance notice.
- * All imperial measurements rounded off to the nearest pound or inch.
- * The air conditioning system on this machine contains the fluorinated greenhouse gas refrigerant HFC-134a (Global Warming Potential = 1430). The system contains 0.55 kg of refrigerant which has a CO2 equivalent of 0.7865 metric tonne.



PLEASE CONTACT