

AXIAL-FLOW®

130-SERIES - 5130 / 6130 / 7130



EFFICIENT POWER EP
MORE PRODUCTIVITY • LESS FUEL

CASE IH
AGRICULTURE

HARVEST YOUR SUCCESS





INTRODUCTION

MORE THAN THREE DECADES OF ROTOR HARVESTING HERITAGE

Over the past 35 years Case IH has optimised the single in-line rotor design to ensure our machines excel in capacity, performance and efficiency. The success of your business is measured by the price you earn for your crop, and whatever the challenges of the growing season, you only have a single opportunity to get it from the field to the farm in perfect condition. No other combine does that as effectively as the Axial-Flow®.

THE PEAK OF PERFORMANCE...

New Axial-Flow® 130 series combines are a match for anything on the market when it comes to sheer output. With up to 415hp on tap and grain tanks that hold as much as 10,570 litres, capacity isn't an issue. These are machines designed to put tonnes in the trailer as fast as possible, in all crops and all conditions – but not at the expense of grain or straw quality. Gentle threshing and quality bedding straw are hallmarks of the latest Axial-Flow® rotors.

...BUT NOT AT ALL COSTS

Case IH engineers understand that, whilst getting grain in the barn is the key to maximising income, fuel is one of farmers' biggest outlays, and that covering the ground quickly means nothing if it comes at the expense of excessive diesel consumption or increased grain losses. At the heart of the new Axial-Flow® series are engine, transmission and rotor refinements designed to extract all power possible from every last drop of diesel and ensure long-lasting reliability of every component. According to independent sources, service and maintenance costs for Axial-Flow® combines are significantly lower than for competitor machines. It's proof of how Case IH is constantly seeking to reduce the impact of its equipment both on your wallet and on the environment.

EASY OPERATION

Axial-Flow® combines have long been renowned for their simplicity. Whilst our machines and the technology they incorporate have come a long way over the past three and a half decades, in the process helping owners to become more productive, one thing that hasn't changed is this commitment to simple, successful principles – in operation, in servicing and in the management of the machine.

A RICH TRADITION

Single rotor combines were pioneered by Axial-Flow® engineers. We have thirty-five years of experience behind us and our belief in the single rotor principle for both threshing and separation is borne out in our dedication to its design. But that means nothing without the backing of the thousands of farmers who have bought Axial-Flow® combines every year since their introduction. This brochure will tell you why we think Axial-Flow® is the way to go – but over 150,000 satisfied customers tell you a whole lot more.

THE SUCCESS STORY

1831

Cyrus McCormick introduces the world's first successful reaper.

1842

Jerome Increase Case produces his first threshing machines in Racine, Wisconsin.

1863

J. I. Case and Company is founded in Racine.

1915

International Harvester builds its first combine.

1977

The first 1400 series Axial-Flow® combines are launched.



1987

A new special rotor design is launched to offer greater threshing performance and efficiency.



1993

The revised 1600 series, the third generation of Axial-Flow® combines, features the new Cross Flow fan system.



2002

The Axial-Flow® rotor is again improved, to offer better performance in robust crops such as rice and beans.



2003

Case IH is the first manufacturer in the business to use touch-screen technology to make combine operation simpler and more efficient, with the launch of the Advanced Farming System display.



The success of Case IH is based upon a strong past. As a result of continuous growth and development, today we are the second largest manufacturer of agricultural machinery in the world. Thanks to continuous development and expansion of our range, Case IH now offers the widest ever portfolio of products to our clients.

2007

The 30th anniversary of the Axial-Flow[®] celebrates six generations of pioneering technology.



2008

The ST rotor, with its improved straw handling ability, maintains high throughput and grain quality whilst saving power and delivering better quality straw, even under high moisture conditions.



2011

The 150,000th Axial-Flow[®] combine leaves the production line in Grand Island, Nebraska.



2012

Case IH takes the next step in Axial-Flow[®] development, introducing new-generation machines featuring Efficient Power engines and a host of other new developments.



HOME OF THE AXIAL-FLOW[®] COMBINE



GRAND ISLAND, NEBRASKA – A TRADITION OF LEADERSHIP

Case IH has powered agriculture for more than 160 years, and the Case IH brand represents a tradition of leadership. Its history is the culmination of the combined efforts of great agricultural equipment companies and brands, including Case, International Harvester and David Brown, to name a few. Each of those brands has played an important role in the history and evolution of Case IH. Over the years, many things have changed, but the legendary red brand will always represent a commitment to making agricultural producers successful.



THE GRAND ISLAND FACILITY

is the CNH North America Combine Centre of Excellence. The state of the art factory is considered one of the premier manufacturing facilities within CNH. Three distinct series of combines are manufactured on the same assembly line, making the Grand Island facility the only CNH plant to utilise mixed model production. Several business units make up the manufacturing portion of the Grand Island plant including fabrication, welding, paint and assembly. Each area uses modern technology to aid in the processes, including an automotive grade e-coat paint system, laser cells, robotic welders and wireless testing systems.



DESIGNED AND BUILT FOR YOU

THE NEW AXIAL-FLOW® 5130, 6130 AND 7130

combines are built to meet the demands of today's mid-sized arable operations, from professional farms to progressive estates. At their heart is the proven principle of Axial-Flow® single rotor technology and the benefits that it brings: thorough threshing, leading to lower losses, but with the gentlest of grain handling.



SINGLE ROTOR SIMPLICITY FROM THE ROTARY INNOVATORS

Since its introduction over three decades ago, the Axial-Flow® has always been a true rotary combine, with a single rotor taking care of both threshing and separation. This time-proven, simple yet effective design makes it one of the most reliable and easy-to-maintain combines available.



AXIAL-FLOW® HEADERS DESIGNED TO GATHER EVERY GRAIN

Latest generation Case IH headers, available in widths up to 7.6m, are designed specifically for European conditions and allow you to make the most of the capacity these combines are capable of. Choose from 3050 VariCut or 2000 series grain headers, and from a range of rigid or folding corn headers,





UNLOADING ON THE HEADLAND? LESS TIME STANDING STILL

The high capacity unload option reduces unloading time in high-yielding crop conditions, improving overall performance during the day. Less time spent unloading on the headland means greater productivity, a big plus when the weather is against you.



A FINE CHOP, A PERFECT SWATH WITH INTEGRATED CHOPPER

The combine is the first tool in establishing next year's crop. With an Axial-Flow®, precision cut at the front and precision chop at the rear mean the perfect start for the next season. Disengage the chopper, though, and you're left with neat rows of straw for baling.



WELCOME TO YOUR HARVEST OFFICE

There's no combine simpler or more comfortable to operate than the latest 130 series Axial-Flow®. The Multifunction Propulsion Control lever places all the key external functions of the combine in the palm of your hand, and for full control, the commands are grouped and arranged in the most ergonomic and logical position following the combine from front to back positions, allowing easy management of all header functions and unloading auger operations.



KEEP A CLOSE EYE ON PERFORMANCE

New Case IH telematics systems connect the combine's on-board recording capabilities and the farm office computer via wireless telecommunications technology to enable machine, agronomic and job site information to be transferred between the two in near real-time. If you run more than one combine, it's possible to view all machines in a fleet on a single web page. An SMS/text message-based alarm system allows to keep an eyes on performance reports, instant tracking and possible fuel theft.

HIGH TECH INSIDE

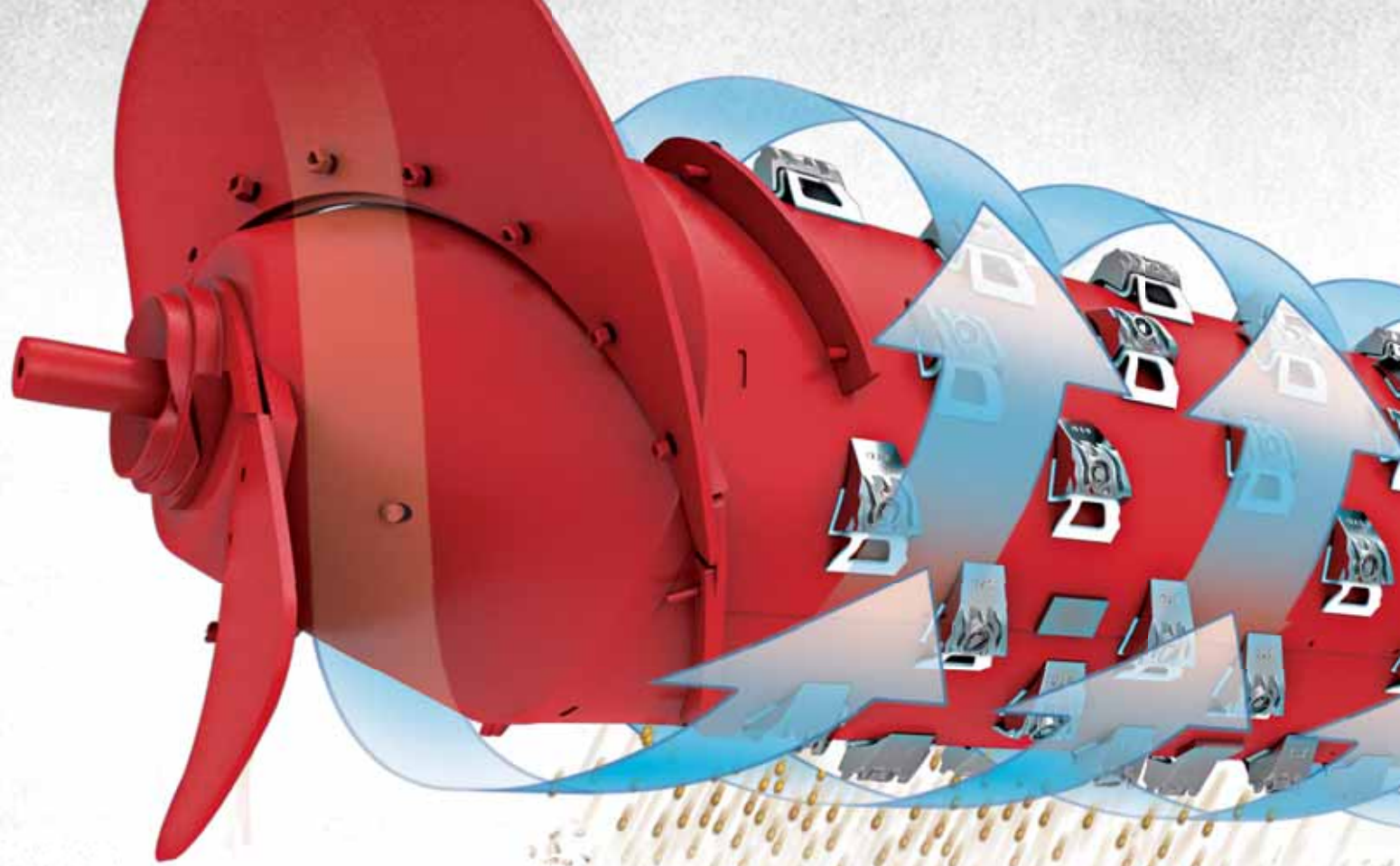

AXIAL-FLOW® ROTOR – THE HEART OF THE PROCESS

At the heart of every Case IH 130 series combine is the latest Small Tube rotor, developed to boost throughputs when it's damp and further improve threshing performance without compromising grain and straw quality, in dry and wet conditions, regardless of the crop being harvested.





SINGLE ROTOR TECHNOLOGY

FROM THE INVENTOR OF AXIAL-FLOW®

Single rotor threshing and separation is a Case IH specialty. We unveiled the first combine range based solely on this system more than three decades ago, and such has been its success that it remains core to our combine range today. But while the principle has remained unchanged, with each range development Case IH engineers have utilised the very latest technology available to meet future farming needs. Axial-Flow® 130 series combines benefit from that same forward thinking, and incorporate some of the very latest concepts not only in threshing and separation, but also in areas from cleaning to unloading, from engine enhancements to transmission technology. The end result is a combine range built not just to meet today's farming challenges – but to take on tomorrow's too.

The grain-on-grain threshing action of Axial-Flow® not only limits grain losses in the field through more effective separation, but also ensures that what goes into the grain tank is unbruised and unbroken, protecting crop quality and adding revenue to your bottom line. There's no high-impact conventional drum like that used in conventional or hybrid combines, and the transition from threshing to separation is completely seamless. High centrifugal forces are achieved at low rotor speeds, but for tougher conditions it's simple to increase the rotor velocity.

Case IH engineers recognise that every grain is precious and that high outputs are no compensation for losing crop out of the back of the combine; that's why they go to great lengths to give you the best separation system in the business. The value of the grain-on-grain threshing that is a hallmark of Axial-Flow® combines is not just based on claims made by Case IH – it's backed by the experience in the field of some of the industry's most respected researchers.

BEST IN CLASS GRAIN QUALITY

Cracked grain is the bane of good sample quality, not only because of the damaged kernels themselves, but also because they can be easily blown out of the back of the combine. With the benefits of Axial-Flow® threshing and the latest Small-Tube rotor, Case IH combines consistently deliver top quality grain samples.

AVERAGE CRACKED GRAIN CONTENT

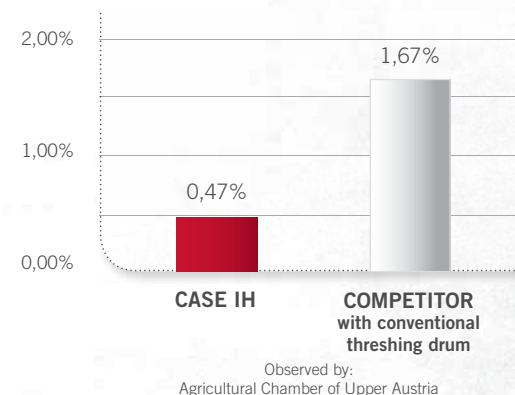

Rasp bars are arranged in four spirals around the rotor, for improved threshing and better straw quality in tough conditions. Access to the rotor cage is possible from both sides of the machine, while lightweight interchangeable modules can be easily removed and changed for different crops – a real Axial-Flow® benefit.

ULTIMATE PRODUCTIVITY





GENTLE THRESHING MEANS MORE GRAIN, MAX QUALITY

- The gentle yet thorough Axial-Flow® system separates out more grain, and leaves it in the best possible condition
- Resulting in both yield and quality gains are reflected directly in your bottom line
- Gentle movement of crop from elevator to transition cone – NO CROP ACCELERATOR NEEDED
- Impeller design moves crop gently from feeding speeds of 8kph to threshing speed of 100kph in less than three seconds
- Axial-Flow® rotor optimises crop flow for gentle threshing and increased throughput in tough conditions
- Impeller moves more than 30m³/min of air, resulting in a cleaner, clearer view of the cutterbar, even at night in dusty conditions. It's an ST rotor exclusive feature



DESIGNED TO GATHER EVERY GRAIN

AXIAL-FLOW® HEADERS

Latest generation Case IH headers, available in widths up to 7.6m, are designed specifically for European conditions, and allow you to make the most of the capacity these combines are capable of. Choose from the 2030 fixed-knife, or 2050 and 3050 variable-knife, for enhanced performance in dense crop conditions and specialised crops.

EASE YOUR OILSEED RAPE HARVEST

On the 2050 and new 3050 VariCut headers, knife position can be moved on the go through a 50 to 57cm range for work in heavy-strawed crops, such as oilseed rape. The results are faster harvesting and lower seed losses.

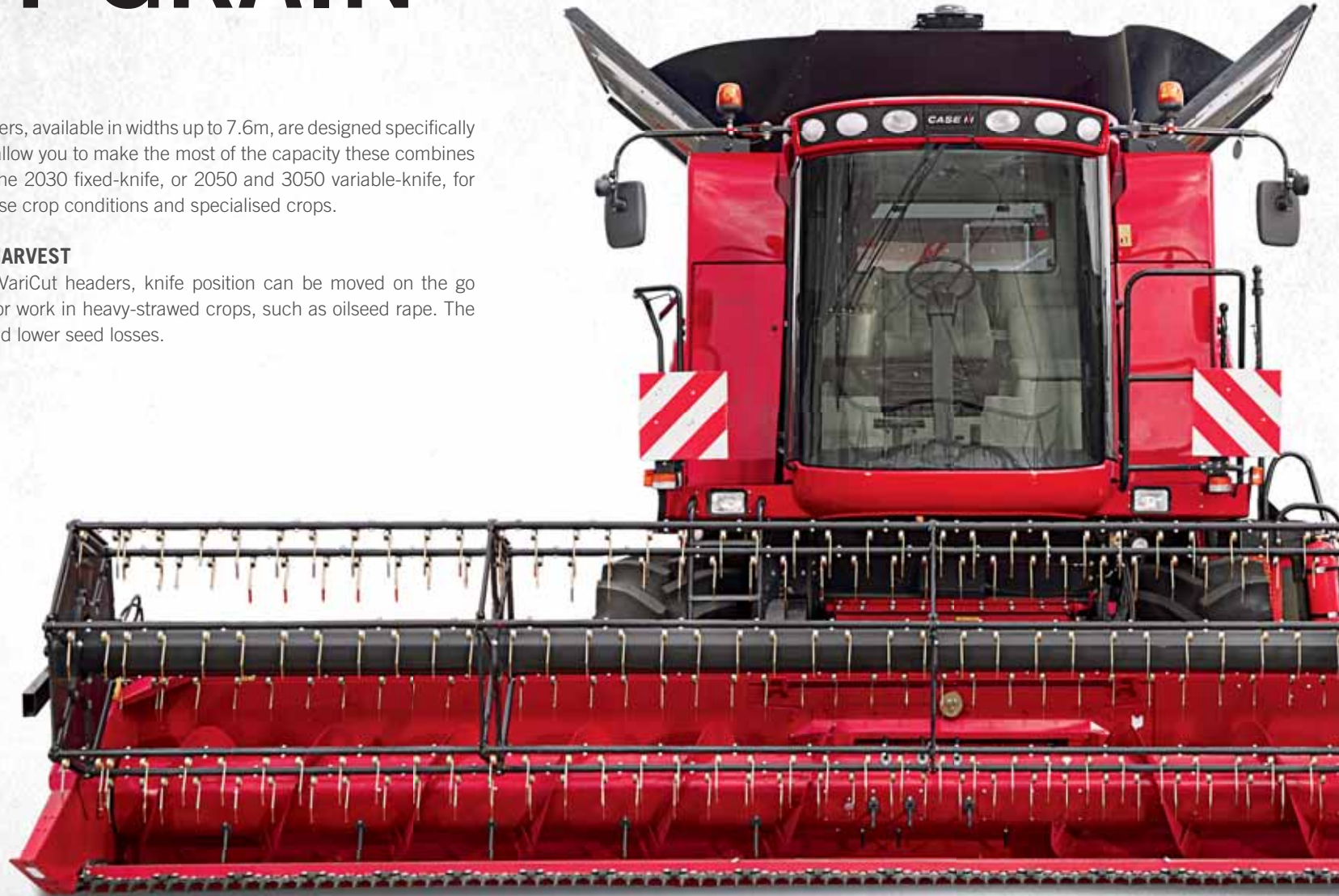

MODEL	HEADER TYPE	MIN.	MAX.
2030	rigid	5.2m	7.3m
2050	variable	5.2m	7.3m
3020*	flex	6.1m	7.6m
3050	variable	4.9m	7.6m
3016*	draper pickup	4.6m	–

* offered in limited markets

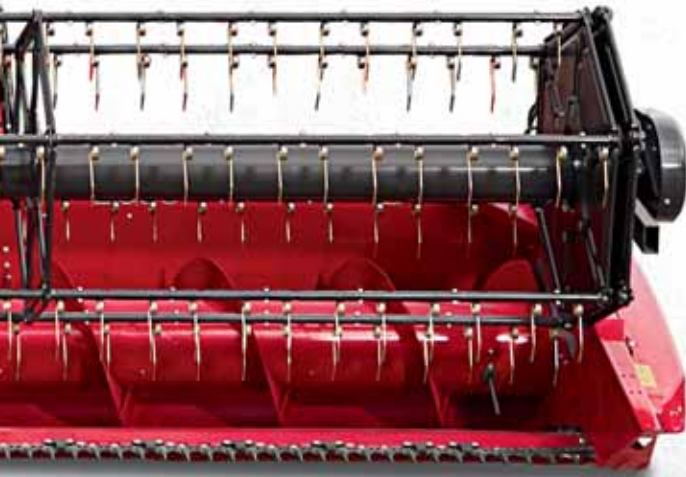

SHARP AND SWIFT

The cutterbars for all Case IH Axial-Flow® combines can be fitted with side-knives which are electrically- or hydraulically-driven on 2050 headers, and hydraulically-driven only on 3050 models. They ensure a clean-cut row edge and minimum losses in all oilseed rape conditions.



ELEVATORS WITH APPETITE

Headers are only half the story when it comes to getting crop into the combine. The Axial-Flow® 130 series feature high capacity elevators to improve the flow of cut crop as it enters the machine – and that's just the beginning when it comes to boosting throughput. Stones and other foreign material are pressed by a slip clutch-protected roller into the stone trap, to prevent any damage to the combine. The large stone trap is conveniently emptied with a lever from the left side of the combine.



QUICK COUPLING

With an Axial-Flow®, even moves between fields are faster. All headers are conveniently coupled to the combine from the left hand side. A single latch connects all hydraulic services. Plug in the electrical connection, couple the PTO shaft, and in just a few minutes you're ready to start harvesting again.



PERFECT GROUND HUGGING

All Case IH headers feature Terrain Tracker as standard equipment. This system is designed to keep the header parallel to the ground, hugging the contours automatically. A uniform cutting height at all combine speeds is ensured as a result.



HIGH CAPACITY CORN HEADERS

ESPECIALLY DESIGNED FOR AXIAL-FLOW® COMBINES



- Powerful performance
- Superior reliability
- Easier maintenance
- Faster harvest speeds
- Highest-quality corn harvesting
- Especially designed for Axial-Flow® combines
- Optional chopping unit available



EXPERT PERFORMANCE IN MAIZE

These rigid or hydraulically folding headers have been specifically designed for Axial-Flow® with strong shaft drivelines to ensure reliability. Cobs are precision picked and handled gently whilst the industry leading stalk chopper completes a perfect job. A consistent short chop length and even spreading of chopped material leaves a clean field behind.



CLEAN PICKING

Aggressive rollers fitted with knives positively pull the maize plant down and past the hydraulically adjustable deck plates that gently strip off the cobs. No stalk escapes the long reversible stalk chopper knives, as they cover the length of the rollers. The cut residue is evenly spread across the full width to ensure thorough and uniform decomposition and create an ideal environment for trouble-free tillage.



HEADER TYPE	ROW SPACING		
	70cm	75cm	80cm
5 row rigid		•	•
6 row rigid	•	•	•
6 row fold		•	•
8 row rigid	•		
8 row fold		•	•



THE HIGHEST GRAIN QUALITY





CLEANING

A CLEANER CROP FOR A PREMIUM PRICE

Axial-Flow® combines have always been acknowledged for thorough threshing and clean crop samples. If there are two things that a combine is rated on, it's how well it threshes, and how well it cleans. Chaff and straw have no place in a grain tank, and that's why Case IH puts a great deal of design thought into creating a combine with one of the best threshing, separation and cleaning systems on the market.



CROSS-FLOW CLEANING

It's not just the rotor that makes the Axial-Flow® different. The Cross-Flow cleaning system which follows the separation process uses chevron-shaped fins to create a uniform vortex along its axis, generating high volumes of air throughput. Unlike conventional systems, there are no air pockets created, with distribution consistent across the underside of the sieves, and fan speed is fully adjustable to cater for finer-seeded crops. The result is higher cleaning capacity, with sieves adjustable from the seat. Each sieve is able to operate at an ideal stroke length, and the opposing motions of the sieves cancel each other out, resulting in a smoothly operating cleaning shoe. Short straw is virtually eliminated, resulting in a cleaner grain tank sample. A fully-adjustable pre-sieve means Axial-Flow® 130 series combines can adapt to all crops and all conditions.

MORE IN THE TANK,
MORE IN THE BANK





GRAIN TANK

Axial-Flow® 130 series combines are designed to put large quantities of clean, undamaged grain in the tank – and fast. Once crops are ripe and ready, we know your priority is to get them off the field and into the shed as quickly as possible.

Every Axial-Flow model has a grain tank that's designed to be big enough to allow the opening up of large, high-yielding fields without the inconvenience of having to stop and unload. For those harvesting specialist feed crops such as corn cob mix (CCM), there's sufficient tank capacity to also accommodate the cob spindles.

Optional in-cab grain tank extension folding makes for easier transport/storage, as well as fast-acting protection if the weather turns bad. The open style extensions widen the grain tank towards the top, to ensure maximum fill without spillage when working on rolling fields. The central grain tank filling auger reaches high over the top to keep filling efficiently without crop pushing back.

When it's necessary to enter the grain tank for servicing, maintenance or cleaning, Case IH engineers have made the task safer and simpler. A ladder makes it easier to gain full access when necessary.

No tools are required to extend or retract the standard grain tank extensions. Axial-Flow® combines are designed to ensure you spend more time in the seat, and less setting up and servicing.

5130	8,800l
6130, 7130	10,570l



WATCH YOUR CASH FLOW





HIGH SPEED UNLOADING

FROM TANK TO TRAILER – FAST

The high speed unloading considerably reduces unloading time, a particularly welcome feature in high-yielding crop conditions, improving overall performance during the harvest day. Less time wasted when unloading on the headland means greater productivity, especially beneficial when the weather is against you.

Case IH combines utilise the top unloading principle to load into high-sided grain trailers and chaser bins quickly and easily. The rubber spout on the end of the unloading tube keeps the crop in a dense stream, minimising the risk of spillage and meaning that it's just as easy to load into smaller trailers.

QUICK, GENTLE AND EFFICIENT

Axial-Flow® 5130 models have an 88 litres/sec maximum unloading rate, while the figure for 6130 and 7130 models is 113 litres/sec. Adjustable, no-tools-required, latched auger tent covers allow easy adjustment to match desired unload rate and reduce torque load. Heavier grain tank cross auger drive chains and sprockets boost performance and extend service life, while auger lengths on all Axial-Flow® models allow you to maintain a comfortable distance between the header and the grain trailer while unloading on the go.

- Top inclined delivery auger allows enough space for the unloading auger to unload into high sided grain trailers.
- Easy view to the unloading auger from the comfort of the cab without any obstructions.



Standard unloading system at
88l/s (5130) and 113l/s
(6130, 7130)

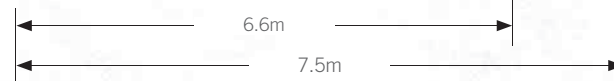

A FINE CHOP AND SPREAD, **A PERFECT SWATH**



THE START OF THE NEXT SEASON

Whatever your crop establishment regime, a combine that has left behind nothing but evenly-distributed and finely-chopped straw on well-cut stubbles is a good start for the next process, whether that's ploughing, minimum tillage or direct drilling. That's what you get with the latest Case IH straw choppers. If you choose to bale your straw, though, you'll also find that there's little left behind afterwards, with Axial-Flow® combines producing neat, easy-to-bale swaths.

KNIFE PROTECTION SYSTEM

In chopping mode, the unique 76 blade chopper lacerates and cuts the straw for fast decomposition before the next planting season. Fixing the counterknives into preset positions in the straw channel allows the chopping aggression to be altered according to the conditions.

In windrow mode the chopper works with reduced speed to place the straw in a neat windrow for efficient baling.



SPREADING

The residue can be spread at the full width of the header, either symmetrically behind the combine or away from the edge of the crop, yet covering the whole area. With the electrical adjustment option for straw distribution, the spreading pattern can be adjusted to account for the prevailing wind conditions, keeping the spread even across the field for fast decomposition, effective soil erosion control and trouble-free tillage.



WINDROWING

The straw can be windrowed with or without the chaff, depending on the preference of the farm or contract customer. The windrow is shaped on the stubble by an adjustable chute.



DISTRIBUTION

A unique Axial-Flow® plus point is the ability to be able to spread out unchopped straw during harvest if it is required for baling but is not fully dry. This reduces drying time, with the straw simply rowed up for baling.



NO SHORTAGE OF POWER



ENGINE

New generation Case IH Axial-Flow® combines use the latest Euro 3B (interim Tier 4A) emissions-compliant engines, but being cleaner doesn't mean being down on power or thirsty on fuel. In addition to removing nitrous oxides and particulates from exhaust gases without recycling them, compared to the previous combines the selective catalytic reduction (SCR) and AdBlue technology used in these engines actually cut the total fuel/Adblue cost by up to 10% depending on model and conditions.

CASE IH FPT 8.7L 6130 & 7130 COMBINES



POWERFUL ENGINE, LOW FUEL CONSUMPTION

Featuring electronic fuel injection, these engines deliver strong power when you need it so you can always harvest and unload at the same time. In addition to its remarkably low fuel consumption, the engine is both quiet and environmentally sound. The 950 litre fuel tank holds more than enough for a full day in the field.

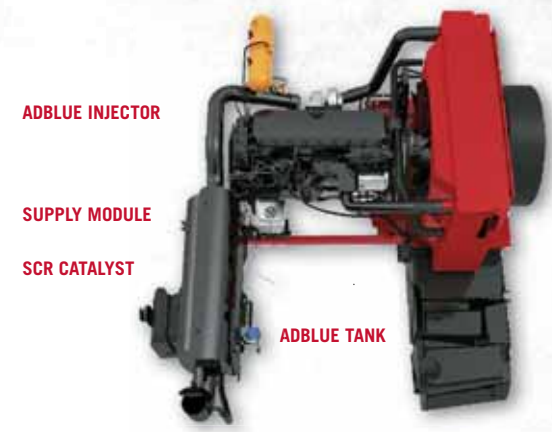

POWER GROWTH (7130)

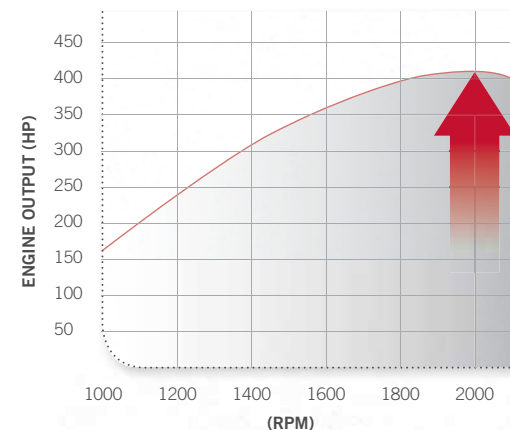

POWER THAT MEETS YOUR EXPECTATIONS

The Tier 4A FPT Industrial engine line used in the new 130 series Axial-Flow® combines is a reliable, proven performer. These engines are designed for optimum fuel efficiency, and to produce the power needed to respond quickly to changing conditions in the field.

LESS COMPLEXITY, MORE PRODUCTIVITY



DRIVELINES

Axial-Flow® combines use a driveline that is as simple and efficient as their threshing system. All key components are powered by a central gearbox mounted directly to the engine for maximum efficiency.

All drive and driven belt pulleys are cast, enabling them to transmit power efficiently for many seasons, increasing the service life of the drive belts. The belt tensions are set according to gauges taking out all the guess work to obtain the optimum drive efficiency.

The result is efficient power transfer even in the most adverse crop and field conditions. It's an established design that has been proven globally, across a whole spectrum of crops, over many years.



THREE-RANGE HYDRO TRANSMISSION

Hydrostatic transmission offers infinite control of ground speed, through a direct coupling from the engine to the hydrostatic pump for instant drive. Three speed ranges from the transmission allow you to select the right speed for the crop and field conditions.



POWERFULL ROTOR DRIVE

The on-the-go adjustable variable speed, belt drive for the rotor utilises a stronger belt to transmit the power for high throughput on the 6130 and 7130 combine. Its “torque sensing” ability, tensions the drive sufficiently for high power demands.



UNCOMPLICATED DRIVELINES

Case IH is known for using very few and very practical placed drivelines, so that access remains easy to all service points.

**WELCOME
TO YOUR
HARVEST
OFFICE**



48 5.8m





THE CAB

Case IH understands the pressures faced by farmers at harvest. We know good labour is hard to find and that many businesses employ only the minimum of staff, whether by choice or necessity. So whoever is in the seat – the farm owner, a skilled operator, or a temporary harvest team member – they need a machine that's easy to operate.

That's why our engineers have created one of the quietest, most spacious and most comfortable cabs on the market, designed for long and profitable working days. A great deal of work has gone into creating a vibration free environment, and an ergonomic control layout that helps reduce fatigue, helped by a large comfortable air ride operator seat that's fully adjustable. With over 5.8m² of glass, vision is impressive, aided at night by outstanding stadium lighting, with a number of options including a package of six HID lights. Further features include a large and convenient storage area and Automatic Temperature Control (ATC).

QUIET, CALM, COMFORTABLE

A Case IH operator deserves a comfortable, user friendly environment. Climb the easy-access, foldable steps to the spacious deck and behind the cab door you'll find ample space and storage, with comfort enhanced by thoughtful details such as an air suspended operator seat, low noise levels and an unrestricted view.

NO LIMITATION ON YOUR WORKING DAY

When the crop is ready and weather conditions are favourable the all-round lighting of Axial-Flow® allows you to continue harvesting safely and efficiently. Stadium lights are fitted to the roof to completely floodlight the work area. Lights in the grain tank, on the unloading auger and at the rear of the combine ensure all critical areas are fully illuminated. A high intensity discharge (HID) lighting package is also available.



CONTROL AT YOUR FINGERTIPS

EMERGENCY
QUICK STOP BUTTON

UNLOADING AUGER
IN/OUT

UNLOADING AUGER
ON/OFF

REEL RAISE, LOWER,
TILT LEFT, TILT RIGHT

HEADER RAISE, LOWER,
TILT LEFT, TILT RIGHT

HEADER
RESUME

ROTOR
ON, OFF, REVERSE

FEEDER
ON, OFF, REVERSE

REEL SPEED
AUTO, MANUAL

AUTO HEADER
HEIGHT
ADJUSTMENT

AUTO HEADER
HEIGHT SET

REEL SPEED



FIELD, ROAD MODE

AUTO GUIDANCE MASTER

UPPER SIEVE POSITION

LOWER SIEVE POSITION

SPREADER ADJUST

GROUND SPEED GEAR SHIFT

THROTTLE CONTROL LEVER
ROTOR SPEED

CLEANING FAN SPEED

POWER GUIDE
REAR AXLE

HYDROSTATIC
RANGE SWITCH

PARKING BRAKE

CONCAVE POSITION

THE CONTROLS

The Axial-Flow® is as simple and comfortable as possible to operate. The number of functions that can be controlled through the joystick has increased and there's a new right-hand console-mounted display which makes monitoring key combine functions much easier. The AFS Pro 700 touch-screen monitor includes video capability and is telematics-ready, and is the basis for moisture and yield monitoring and steering guidance.

Case IH engineers have thought through every little detail on how the operator interacts with the machine to ensure Axial-Flow® 130 series combines are intuitive in operation, so it's easy to quickly get the best out of them.

For full control, the most commonly used commands are arranged in the best ergonomic position, allowing easy management of all header functions and operation of the unloading auger. In addition an emergency stop button is included to halt the elevator, cutterbar and header auger.

All major controls are integrated into the right hand console and the multifunction control lever.

ULTIMATE PRECISION

AFS



A MODULAR APPROACH

CASE IH ADVANCED FARMING SYSTEMS (AFS®) have been at the forefront of precision farming for more than a decade, giving farmers the ability to control the entire crop production cycle. Case IH AFS® tools include everything you need to achieve repeatable accuracy down to 2.5cm, reduce overlaps and cut input costs – and maximise your yield potential.



ADVANCED COMBINE CONTROL

If it's an interactive combine set-up and control you then need to look no further than at the AFS Pro 700 touch-screen which is fitted standard in your new 130 series Axial-Flow®: monitor yield, fuel usage and work rates, connect external cameras and keep harvest records. The AFS Pro 700 touch-screen is interactive, fully customisable and portable between your Case IH fleet.



COMBINE GUIDANCE SOLUTIONS:

AFS AccuGuide: GPS based guidance for ultimate precision independent of crop conditions. Accuracy levels down to 2,5cm available.

AFS Cruise Cut: Optical guidance system, ideal if 2 or more combines run in the same field.

AFS Row Guide: Mechanical row sensors combined with GPS guide the combine exactly through corn rows, whether straight or curved.



AFS® FARM MANAGEMENT SOFTWARE

Many variables apply in farming; it is important to understand what is happening and why. It's time to manage your farming operation on a new level by making decisions based on facts. With the AFS® Farm Management software package from Case IH you can see field by field the tasks performed, the work rates achieved, the fuel used during each task and most importantly your yield. Plan for the future today.



AFS CONNECT™ TELEMATICS

The Case IH AFS Connect™ telematics system allows you to monitor and manage your Axial-Flow® from the farm office, tracking it in real time on the farm computer to observe how it is performing, as well as allowing remote diagnostics and driver communication, through the use of precision GPS signals and wireless data networks. Analysing the data it provides helps to improve logistics, minimise fuel consumption and maximise performance.



INTERACTIVE
INTEGRATED
INTUITIVE



ADVANCED COMBINE CONTROL

The screen arrangement of the AFS Pro 700 touch-screen monitor option is logically configured. The left side provides full information on all important operating data, while to the right different 'templates' can be called up, such as those that display current combine settings or yield monitoring data. One template is reserved to display the status of the combine sensors and the operator can configure his own templates to suit. The AFS Pro 700 touch-screen also displays video pictures taken from mounted cameras.

KEY FEATURES INCLUDE:

- **Performance monitoring** of fuel usage, engine load, yield, moisture, work rates, either live and specific to the job or as daily averages.
- **Record keeping** under the Grower Farm Field structure. All data can be stored onto USB stick for analysis in the farm office.
- **Vehicle setup** such as Automatic Crop Settings (ACS), header adjustment and other important combine parameters.
- **AFS AccuGuide Guidance** Set up a new AB line and start handsfree harvesting! AFS AccuGuide is fully controlled via the AFS Pro 700 touch-screen monitor, easily engaged via a dedicated button on the propulsion lever and ensures that your Axial-Flow® is utilising its full header width and runs at 100% capacity.
- **Video input** from up to 3 video cameras to watch hidden areas behind the machine or see into the trailer from a camera mounted to the unloading auger.



Ideal for contractors, on combines equipped with yield monitoring a job printer allows performance and area data to be printed and handed over to the customer at the end of each job.



AXIAL-FLOW® GUIDANCE SOLUTIONS

AFS ACCUGUIDE GPS-CONTROLLED AUTO-STEERING

Reap the benefits of a very capable single screen solution. Performance monitor, vehicle setup, record keeping, mapping, video and AFS AccuGuide are all in one place on the AFS Pro 700 touch screen monitor and 100% part of your operating environment.

FAR MORE THAN JUST A SAVING ON FUEL – THE AFS ACCUGUIDE EFFECT:

- Optimized machine usage
- Improved comfort by reducing operator demands
- Savings on fuel and labour costs
- Reduces time spent in the field
- Reduces skips and overlaps – improves efficiency
- Perfect work in poor visibility conditions without compromise

MECHANICAL ROW GUIDANCE

A simple mechanical system ensures the combine follows the rows in maize crops. It takes the stress out of harvesting at high forward speeds and when using wide headers, reducing operator fatigue and boosting productivity, to exploit the combine's full performance capabilities.



AFS TELEMATICS

AFS CONNECT IS AVAILABLE IN TWO SPECIFICATION LEVELS:

AFS Connect Manager offers fleet management capabilities, machine location tracking and a working status overview. Alerts and security features to guard against theft or misuse include geo-fencing to ensure a machine stays within certain boundaries, and curfew management to send an alert if a machine is started after working hours.

AFS Connect Executive* includes all the components of AFS Connect Manager, plus some significant enhancements. These include:

- A two-way messaging feature so that farmers/managers can select the machines to which they want to send information. Messages can appear on each machine's display instantaneously, and machine operators can respond for validation.
- Virtual display, with which farmers/managers are able to see the monitor in each machine from their computer, with information updated every 15 minutes. Coverage area, machine hours, fuel use and a vast array of other data can be reviewed, and the computer view can be customised to display information in the most efficient, effective manner.

VIRTUAL DISPLAY ON PC

Virtual display on the farm office PC allows owners and managers to control machine performance and send messages to help the operator to work at the best performance levels to achieve the highest possible productivity.

	AFS Connect Manager	AFS Connect Executive*
Fleet management	•	•
Machine position	•	•
Machine hours	•	•
Geo-fencing alarms	•	•
Curfew alarms	•	•
Fuel and productivity reports		•
Virtual display		•
Diagnostics		•
Messaging		•

*) available in 4th quarter 2012



DON'T LOSE PRECIOUS TIME

ON DAILY CHECKS
AND MAINTENANCE



SERVICEABILITY

MAXIMUM UPTIME, MINIMUM SERVICE COSTS - WHAT YOU WANT, WHAT WE FOCUS ON

When there's a full day's harvest ahead of you, the last thing you want is a machine that's time-consuming to service. Daily checks and regular maintenance are simple when you run an Axial-Flow®.

Keeping you working and reducing maintenance and costly downtime are key Case IH aims. Case IH Efficient Power EP Axial-Flow® combines have fewer moving parts than comparable machines, and together with the way in which they are designed and built, this results in operating costs lower than those of key competitor combines.



When you buy a Case IH machine, you can be sure not only that you're buying the best product, but also that you've got the best dealer back-up behind you. Case IH dealers can offer advice on selecting and financing the right machine, they ensure to deliver what you need and when you need it, and then continue to back you and your equipment with the service and spare parts supply you'd expect from a name as trusted as Case IH.



ALL THE PARTS AND SERVICE TO KEEP YOUR EQUIPMENT RUNNING

Find the full line of Case IH parts and components at your local dealer, plus full-service maintenance programmes and industry-leading warranties. It's expertise applied by skilled, factory-trained service professionals committed to providing you maximum uptime, season after season.



AROUND THE CLOCK. AROUND THE COUNTRY

Case IH Max Service is a customer support service that provides 24-hour, seven-day-a-week access to the people, products, and parts support needed to keep your operation running during the times most critical to your profitability. Max Service backs up your dealer with every resource available to Case IH, to help maximize uptime and productivity of Case IH equipment and increase your return on investment through access to product experts and 24/7 Emergency Breakdown Assistance.



OFFERING FINANCING SOLUTIONS FOR MORE THAN 50 YEARS

CNH Capital's extensive experience in the agricultural industry has created a deep understanding of your unique needs. Competitive equipment financing with flexible payments can reduce upfront costs with operating and finance leases. For other needs choose from credit cards specific to the agricultural industry. We can even help you finance crop-input products or land rental. There are financing options that fit the way you farm. CNH Capital helps you find them.

**VISIT OUR FANSHOP AT
WWW.CASEIHSHP.COM**





MODELS	AXIAL FLOW® 5130 Efficient Power	AXIAL FLOW® 6130 Efficient Power	AXIAL FLOW® 7130 Efficient Power
HEADERS			
Grain header cutting widths (m)	4.9 / 5.2 / 6.1 / 6.7	4.9 / 5.2 / 6.1 / 6.7 / 7.3 / 7.6	4.9 / 5.2 / 6.1 / 6.7 / 7.3 / 7.6
Knife to auger distance - 2030 / 2050 / 3050 grain header (mm)	550 (2030 header) / 570-1070 (2050 header) and 570-1140 (3050 header) adjustable from cab		
Corn header model 2105 / 2106 / 2108 rigid and foldable	5 row & 6 row chopping corn heads	5, 6 & 8 row chopping corn heads	
THRESHING / SEPARATING			
Rotor speed range (rpm)	250 - 1,150 (3 ranges)	250 - 1,150 (3 ranges)	250 - 1,150 (3 ranges)
Rotor diameter and length (mm)	762 / 2,794	762 / 2,794	762 / 2,794
Total separation area (m²)	2.8	2.8	2.8
Threshing / separating modules wrap angle (°)	156 / 133	156 / 133	156 / 133
Number of threshing / separating modules	3 / 3	3 / 3	3 / 3
CLEANING SYSTEM			
3 steps cleaning system	●	●	●
Cleaning shoe width (mm)	1,47	1,47	1,47
Total sieve area under wind control (m²)	5.52	5.52	5.52
CLEANING FAN			
Fan speed range (rpm)	450 to 1,300	450 to 1,300	450 to 1,300
RETURN SYSTEM			
Tailings return type	To rotor	To rotor	To rotor
GRAIN TANK / UNLOADING			
In-cab control of grain tank covers	●	●	●
Grain tank capacity (l)	8,810	10,570	10,570
Unloading rate (l/s)	88	113	113
Unloading auger effective length, measured from middle of combine to tip of unloading auger (standard/option) (m)	6.6 / 7.5	6.6 / 7.5	6.6 / 7.5
STRAW CHOPPER & SPREADER			
Number of knives: chopper/counterbar	76 / 47	76 / 47	76 / 47
Spreader type	twin 2-speed spreaders / detachable		
ENGINE ¹⁾			
Type / Capacity (cm³)	Turbocharged, intercooled / 6,700	Turbocharged, intercooled / 8,700	Turbocharged, intercooled / 8,700
Max. power ECE R120 ¹⁾ at 2000 rpm (kW/hp(cv))	220/299	285/387	305/415
Fuel tank, diesel/urea (l)	950 / 166	950 / 166	950 / 166
TRACTION			
Transmission	Hydrostatic drive, 3 speed ranges	Hydrostatic drive, 3 speed ranges	Hydrostatic drive, 3 speed ranges
Heavy duty adjustable steering axle	●	●	●
Powered rear axle	○	○	○
ADVANCED FARMING SYSTEMS (AFS)			
Yield & moisture monitoring / mapping	○ / ○	○ / ○	○ / ○
AFS Precision Farming ready and Guidance ready	○	○	○
OVERALL MACHINE SPECS			
Length – feeder to rear trim panel (mm)	7,689	7,689	7,689
Wheel base (mm)	3,815	3,815	3,815
Minimum height (transport) (mm)	3,898	3,906	3,906
Width with 650/75R32 tyres fitted – min (mm)	3,300	3,300	3,300
Approximate of basic machine (kg)	15,400	16,200	16,200
TYRE OPTIONS			
Front tyres	650/75R32 LI172 R1W / 800/65R32 LI172 R1W / 900/60R32 LI176 R1W		
Rear tyres	460/70R24 LI152A8 R4 / 480/70R30 LI152 R1W / 600/65R28 LI154A8 R1W		

¹⁾ FPT Industrial-engine

¹⁾ ECE R-120 correspond to ISO TR14396

● Standard

○ Optional at extra cost

 Safety never hurts! Always read the Operator's Manual before working with any equipment. Inspect equipment before using it, and be sure it is operating properly. Follow the product safety signs, and use any safety features provided. This literature has been published for worldwide circulation. The standard and optional equipment and the availability of individual models may vary from one country to the next. Case IH reserves the right to undertake modifications without prior notice to the design and technical equipment at all times without this resulting in any obligation whatsoever to make such modifications to units already sold. Whilst every effort is made to ensure that the specifications, descriptions and illustrations in this brochure are correct at the time of going to press, these are also subject to change without prior notice. Illustrations may show optional equipment or may not show all standard equipment. Case IH recommends **AKCELA** lubricants.

CNH UK Ltd., Cranes Farm Road, Basildon, Essex SS14 3AD

© 2012 CASE IH - www.caseih.com - © 2012 Case IH - Axial-Flow®-COM-BR - Free phone 00800 22 73 44 00 - Printed in Italy - 10/12 - TP01 - Cod. 12C0001/COM



www.caseih.com