



EK-X technical data.

Vertical order picker



				STILL	STILL	STILL	
				EK-X single lift mast b ₁ = 790	EK-X single lift mast b ₁ = 980	EK-X telescopic lift mast	
Characteristics	1.1	Manufacturer					
	1.2	Type designation					
	1.3	Drive(electric, diesel, petrol, mains plug)			electric	electric	electric
	1.4	Control (hand, pedestrian, stand-on, driver seat, order picker)			order picker	order picker	order picker
	1.5	Load capacity/load	Q	kg	1000	1000	1000
	1.6	Load centre	c	mm	400	400	400
	1.8	Load distance	x	mm	180 ⁹⁾	180 ⁹⁾	150 ⁹⁾
	1.9	Wheel base	y	mm	1270	1260	1415
	Weights	2.1	Dead weight (incl. battery)		kg	varying 1564 - 1793	varying 1740 - 1969
2.2		Axle loadings laden drive end/load end		kg	varying ³⁾	varying ³⁾	varying ³⁾
2.3		Axle loadings unladen drive end/load end		kg	varying ³⁾	varying ³⁾	varying ³⁾
Wheels	3.1	Tyres (solid rubber, Vulkollan, pneumatic, polyurethane)			polyurethane	polyurethane	polyurethane
	3.2	Wheel diameter/width drive end		mm	250/100	250/100	250/100
	3.3	Wheel diameter/width load end		mm	150/100	150/100	150/100
	3.5	Wheels, number (x=driven) drive end/load end			1x/2	1x/2	1x/2
	3.6	Track width, drive end	b ₁₀	mm	0	0	0
	3.7	Track width, load end	b ₁₁	mm	655	835	835
	Dimensions	4.2	Closed height	h ₁	mm	varying ¹⁾	varying ¹⁾
4.4		Lift height	h ₃	mm	varying ¹⁾	varying ¹⁾	varying ¹⁾
4.5		Overall height mast raised	h ₄	mm	varying ¹⁾	varying ¹⁾	varying ¹⁾
4.7		Height to top of guard (cabin)	h ₆	mm	2250 ²⁾	2250 ²⁾	2250
4.8		Platform height, lowered	h ₇	mm	200	200	200
4.11		Auxiliary lift	h ₉	mm	800 ¹⁾	800 ¹⁾	800 ¹⁾
4.14		Platform height, raised	h ₁₂	mm	varying ¹⁾	varying ¹⁾	varying ¹⁾
4.14.1		Picking height (h ₁₂ + 1600)	h ₂₈	mm	varying ¹⁾	varying ¹⁾	varying ¹⁾
4.15		Height lowered	h ₁₃	mm	65	65	65
4.19		Overall length (incl. fork)	l ₁	mm	2450 - 2460 ³⁾	2460 - 2470 ³⁾	2585 - 2615 ³⁾
4.20		Length to front face of forks	l ₂	mm	1650 - 1660 ³⁾	1660 - 1670 ³⁾	1785 - 1815 ³⁾
4.21		Overall width of chassis	b ₁ /b ₂	mm	790/790	980/980	980/980
4.22		Fork dimensions	s/e/l	mm	55/120/800	55/120/800	55/120/800
4.23		Fork carriage to DIN 15173, class/form A/B		mm	welded fork	welded fork	welded fork
4.24		Fork carriage width	b ₃	mm	740 ⁴⁾	740 ⁴⁾	740
4.25		Overall fork width min./max.	b ₅	mm	640/640	640/640	640/640
4.27		Width over guide rollers	b ₆	mm	-	varying ⁵⁾	varying ⁵⁾
4.31		Floor clearance, laden below mast	m ₁	mm	38	38	38
4.32		Floor clearance, centre of wheelbase	m ₂	mm	38	38	38
4.34		Working aisle width at l ₆ x b ₁₂ 800 x 1200 mm (across the aisle)	A _{st}	mm	-	1380	1380
4.35		Turning radius	W _a	mm	1470	1480	1635
4.42	Transfer aisle width, laden with pallet l ₆ x b ₁₂ 800mm x 1200 mm min.	A _u	mm	varying 2819 - 2828 ³⁾	varying 2829 - 2838 ³⁾	2984	
Performance	5.1	Speed laden/unladen		km/h	9,0/9,0	10,0/10,0	10,0/10,0
	5.2	Lift speed laden/unladen		m/s	varying ³⁾	varying ³⁾	varying ³⁾
	5.3	Lowering speed laden/unladen		m/s	0,30/0,24	0,30/0,24	0,30/0,24
	5.9	Acceleration time (over 10m) laden/unladen		s	7/7	7/7	7/7
	5.10	Brakes			generator	generator	generator
	Electric motors	6.1	Drive motor, capacity		kW	3,0kW / S2=60min	3,0kW / S2=60min
6.2		Lift motor, capacity		kW	varying 3,2-4,0 kW/S3=10%	varying 3,2-7,6 kW/S3=10%	varying 3,2-7,6 kW/S3=10%
6.3		Battery to IEC 254-2;A,B,C, no			IEC 254-2; B	IEC 254-2; A	IEC 254-2; A
6.4		Battery type, voltage, nominal capacity K _s		V/Ah	PzS, 24V, 420Ah ⁶⁾	PzS, 24V, 560Ah ⁶⁾	PzS, 24V, 560Ah ⁶⁾
6.5		Battery weight +/- 5% (dependent on manufacturer)		kg	385 ⁷⁾	502 ⁷⁾	502 ⁷⁾
Other	8.1	Drive control			micro processor	micro processor	micro processor
	8.4	Noise peak at operator's ear		dB(A)	61 ⁸⁾	61 ⁸⁾	61 ⁸⁾

¹⁾ see mast table

²⁾ no overhead guard for h₁ = 1,500 mm

³⁾ see special VNAP table

⁴⁾ version with additional lift

⁵⁾ b₆ = 1200 mm to 1740 mm

⁶⁾ standard battery, higher battery capacity possible

⁷⁾ other batteries will affect these values

⁸⁾ values for 3.2 kW lift motor, larger drives will affect these values

⁹⁾ with extra lift x = 190mm for standard mast and x = 180 mm for tele mast

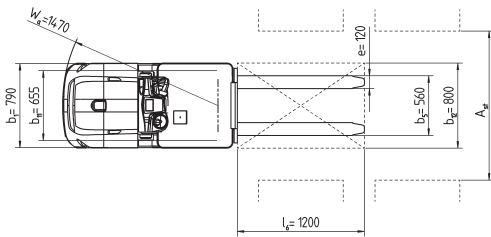
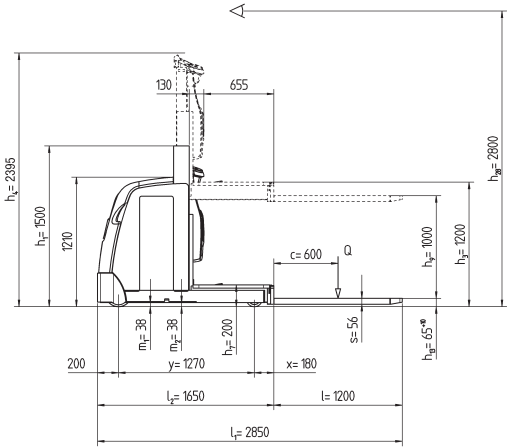

Single lift mast 1500 without auxiliary lift

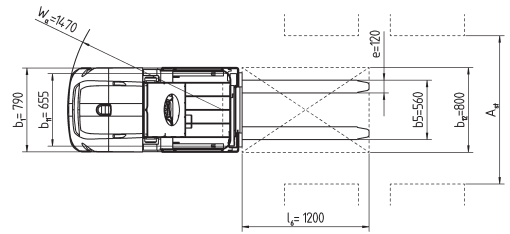
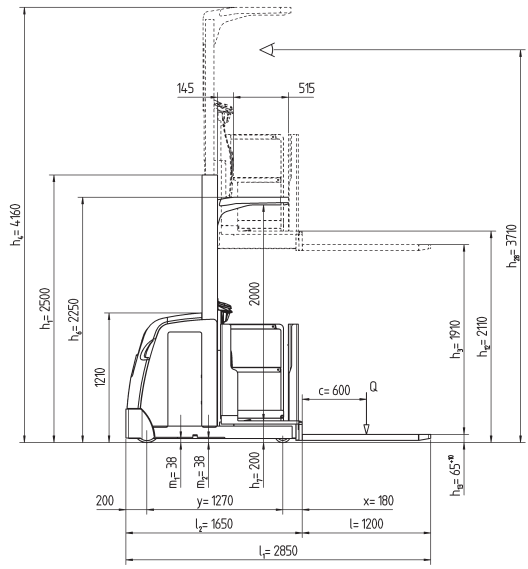

Single lift mast 2000/2500 without auxiliary lift

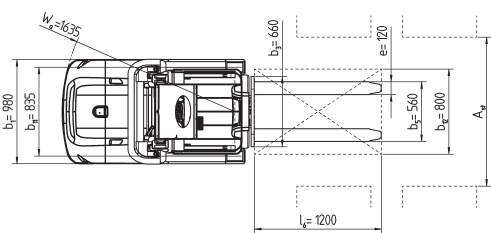
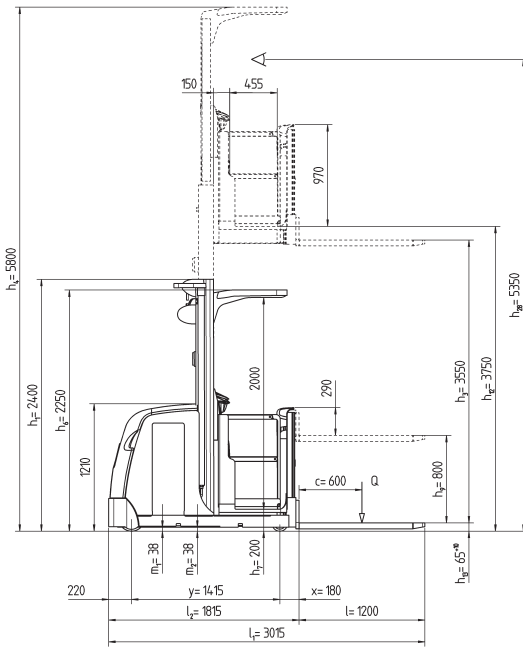

Telescopic lift mast 2400/2900 with auxiliary lift

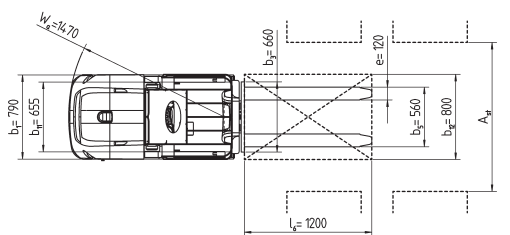
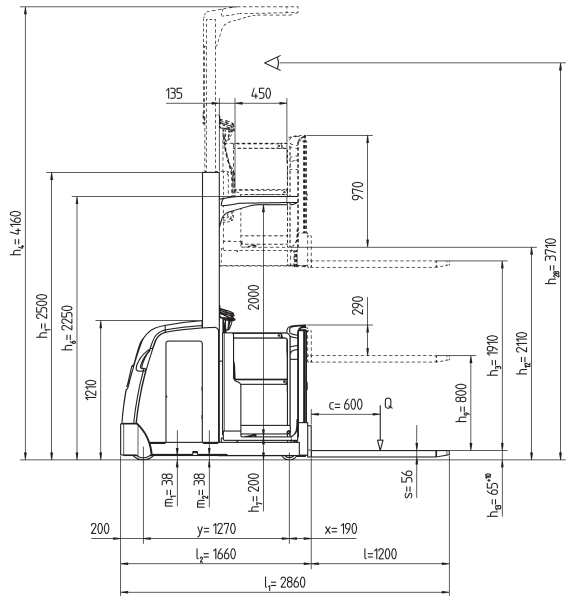

Single lift mast 2000/2500 with auxiliary lift

EK-X vertical order picker.

STILL presents the new EK-X generation with future-oriented truck concept, OPTISPEED.

This truck generation features:

- ergonomic work space with a unique control concept and up-to-date sensor technology for fatigue-free two-handed operation.
- high lift and picking heights at minimum dimensions of the truck and load weights up to 1,000 kg.
- scalable dimensions and performance - modular design for individual adaptation to every customer demand.
- Optispeed truck concept - more performance and safety due to stepless adjustment of the drive profiles to the actual lift height.
- high turnaround performance thanks to powerful drive technology.
- maintenance-free AC-technology drive for optimum availability.
- common parts from other models within the STILL range for proven reliability.
- one of the shortest trucks with the narrowest chassis available on the market - flexible use in even the tightest of warehouses.
- low energy consumption by modern drive and control technology.
- reduced operation costs thanks to simplified service and on-board diagnostics.

Operator's compartment.

- Spacious cabin makes all pick jobs up to 6.35 m easy. Best ergonomics in class, with rounded edges and a comfortable and easy to use foot switch allowing optimum posture of the operator for fatigue-free operation.
- Ergonomic controls clearly and unmistakably arranged. The pick railing with its short head length allows optimum reach of the pallet. This ensures excellent ergonomics and efficiency when order picking.
- Central upholstered foot mat reduces body vibrations of the operator, greatly reducing the strain to the spinal column when driving. Conversely, either side of the foot mat is not upholstered, thus offering a hard floor for better stability when picking.
- Large storage compartments and bottle holder below the control panel.

Display.

- Integrated display, easy reading of operation hours, position of the drive wheel, battery condition, information on maintenance and service.
- Two available display versions: standard display with 7 segment LED indicator, or LCD indicator with numeric key pad with indication of driving speed and lift height.
- Clear and easy to use membrane key to toggle the indicated information.

Modern and high performing technology.

- Powerful 24V AC drives, maintenance-free for high availability and higher turnaround. Dynamic and sensitive controls operate independently of the load weight and travel speed.
- Energy recovery under braking.
- Powerful proportional hydraulics for sensitive lifting.
- Selectable power modules for lift, which are flexible enough to match every customer demand.

OPTISPEED – the future oriented control concept.

- Automatic speed control and progressive stop of movements of the telescopic lift mast, stepless adjustment of speed to actual lift height, optionally with steering angle controlled curve speed reduction. High efficiency and safety when order picking inside the aisle due to optimised movements.

Steering.

- Fully electric easy to operate steering for smooth positioning at the pick position and when stacking pallets.
- High safety by redundant 2 channel steering system.
- Steering wheel with 6 revolutions for 180° steering angle of the drive wheel, optional steering knob with marked neutral position and stop position.
- Directly toothed steering drive - maintenance-free and reliable.



Chassis.

- Torsion resistant steel construction.
- Two frame widths and two overhead guard heights to suit individual applications.
- Narrowest order picker on the market: 790 mm chassis available for narrow warehouses and block storage.
- Different frame width and operator cabin options allow the truck to be tailored to the individual application.
- Impact resistant ABS plastic drive cover - very stable, unbreakable, light and easy to handle.

Mast and hydraulics.

- Torsion resistant lift masts offer maximum safety.
- Single and telescopic masts available, with or without auxiliary lift.
- Height measuring equipment as standard on telescopic lift mast for exact positioning of the fork when staking loading aids.
- Optimum view onto the load at all times thanks to innovative design arrangement of the mast profiles, wires and pipes.
- The electric lift stop at the end position stops progressively when reaching maximum lift height, preventing strain to the truck and driver as no mechanical stoppers are used.
- Hydraulic dampening when lowering the platform - soft ramp function at stop positions avoid body vibration to the driver.

Fork carriage and fork.

- Various fork carriages available, with or without auxiliary lift, for different applications and loading aids. Different forks, fixed or adjustable, for FEM fork carriages.

Brakes.

- Wear-free generative operation brake with energy recuperation when slowing down.
- The electromagnetic parking brake is set automatically when the operator leaves the truck. High safety, no accidental rolling off.

Battery and battery compartment.

- Battery capacities from 360 Ah to 930 Ah for individual adaptation to single or multi-shift operation.
- Battery change by hoist (for 790mm chassis) or from either side by roller track and changing frame.

Safety and quality.

- Truck made in compliance with EC guide lines bearing the CE label.
- STILL is ISO 9001 certified.

Diagnostics and service.

- Central service interface and Service Tool Box allow efficient configuration, parameterisation and on-board diagnostics.
- Simplified service - good accessibility and minimised service costs.



EK-X single lift mast height 1,500 mm



EK-X single lift mast height 2,000/2,500 mm



EK-X telescopic lift mast height 2,400/2,900 mm

Additional equipment (options).

- Battery compartment with roller conveyor.
- Lateral battery covers.
- Operator's cabin for walk-on pallet.
- Auxiliary lift.
- Guidance with lateral guide rollers for aisles with rail guides.
- Feed-in rollers (2x or 4x) to facilitate positioning in the rack for optimum pick distance.
- Various railings for walk-on pallets.
- Various fork widths.
- Antistatic versions.
- Cold storage version.
- Various fork carriages.
- Upholstered railing.
- Makrolon OHG cover.
- Storage compartments and writing pads.
- Writing pad with paper holder.
- Rear view mirror.

Additional electric equipment (options).

- PIN code access control by key pad.
- FleetManager Light – access control by data card/card reader.
- Automatic aisle recognition for mechanic guidance, operated by light sensors.
- Automatic end of aisle braking.
- Pedestrian operation for order picking at floor level.
- Lift switch off inside and/or outside of aisle.
- Drive switch off at defined lift height.
- Load end operation of the auxiliary lift.
- Contactless collision protection on overhead guard.
- Electric monitoring of battery lock.
- STILL MMSi data terminal, scanner and printer.
- Preparation for Materialflow Management System.
- Online-X Module for online diagnostics and service support.
- Fan in overhead guard.
- Cabin lighting.
- Hazard warning light.
- Radio preparation.

Single lift masts with auxiliary lift

Closed mast height h_1	Overall lift above floor $h_{25} (h_3+h_9+h_{13})$	Total lift $h_{24} (h_3+h_9)$	Main lift h_3	Closed height h_{13}	Auxiliary lift h_9 800	Platform height $h_{12} (h_3+h_7)$	Picking height $h_{28} (h_{12}+1600)$	Max. height $h_4 (h_3+h_6)$
1.500	1.865	1.800	1.000	65	800	1.200	2.800	2.395
2.000	2.365	2.300	1.500	65	800	1.700	3.300	3.750
2.500	2.775	2.710	1.910	65	800	2.110	3.710	4.160

Single lift masts without auxiliary lift

Closed mast height h_1	Overall lift above floor $h_{25} (h_3+h_9+h_{13})$	Total lift $h_{24} (h_3+h_9)$	Main lift h_3	Closed height h_{13}	Auxiliary lift h_9 800	Platform height $h_{12} (h_3+h_7)$	Picking height $h_{28} (h_{12}+1600)$	Max. height $h_4 (h_3+h_6)$
1.500	1.065	1.000	1.000	65	0	1.200	2.800	2.395
2.000	1.565	1.500	1.500	65	0	1.700	3.300	3.750
2.500	1.975	1.910	1.910	65	0	2.110	3.710	4.160

Telescopic lift masts with auxiliary lift

Closed mast height h_1	Overall lift above floor $h_{25} (h_3+h_9+h_{13})$	Total lift $h_{24} (h_3+h_9)$	Main lift h_3	Closed height h_{13}	Auxiliary lift h_9 800	Platform height $h_{12} (h_3+h_7)$	Picking height $h_{28} (h_{12}+1600)$	Max. height $h_4 (h_3+h_6)$
2.400	4.415	4.350	3.550	65	800	3.750	5.350	5.800
2.900	5.415	5.350	4.550	65	800	4.750	6.350	6.800

Telescopic lift masts without auxiliary lift

Closed mast height h_1	Overall lift above floor $h_{25} (h_3+h_9+h_{13})$	Total lift $h_{24} (h_3+h_9)$	Main lift h_3	Closed height h_{13}	Auxiliary lift h_9 800	Platform height $h_{12} (h_3+h_7)$	Picking height $h_{28} (h_{12}+1600)$	Max. height $h_4 (h_3+h_6)$
2.400	3.615	3.550	3.550	65	0	3.750	5.350	5.800
2.900	4.615	4.550	4.550	65	0	4.750	6.350	6.800

Intermediate heights on request.





Your contact

STILL GmbH
Berzeliusstraße 10
D-22113 Hamburg
Telephone: +49 (0)40/73 39-2000
Telefax: +49 (0)40/73 39-2001
info@still.de

For further information please visit:
www.still.de

STILL Materials Handling Ltd.
Aston Way, Leyland
Lancashire PR26 7UX
Telephone: +44 (0)1772 644300
Telefax: +44 (0)1772 644303
info@still.co.uk

For further information please visit:
www.still.co.uk